

# Addendum A - SERVICE MANUAL

---

## Agilent Technologies Model E4350B and E4351B Solar Array Simulators - P/N 5962-8233

For units with serial numbers:

E4350B	US37410101 and up
E4351B	US37430101 and up

---

## Foreword

This addendum contains information for troubleshooting and repairing the Agilent E4350B and E4351B Solar Array Simulators. The standard Service Manual for the Agilent Series 665xA DC Power Supplies (P/N 5959-3376), together with this Service Addendum, is shipped with the Solar Array Simulators when ordered with Option 910.

---

**Note** This addendum is to be used along with the standard Service Manual for the Agilent Series 665xA DC Power Supplies. When troubleshooting the Agilent E4350B/E4351B Solar Array Simulators, start by following the procedures outlined in the standard Service Manual. This addendum documents only the differences between the standard troubleshooting procedures and the troubleshooting procedures for a Solar Array Simulator.

---

## Areas of Difference

From a service point of view, the main difference between the SAS unit and the Agilent Series 665xA dc power supply is the addition of a Digital Signal Processor (DSP) board located over the main A1 board. This DSP board includes the portions of CV, CC, OV, and OC control circuits such as the programming DAC circuits, as well as a microprocessor and programmable gate array that is used to generate the output I-V curve. The output I-V curve simulates the output characteristics of a solar array.

The areas in the standard service manual that are changed by this addendum are:

- Test Equipment Required (Table 2-1)
- Basic Test Setup (Figure 2-1)
- Voltage and Current Values (Table 2-3)
- CC RMS Noise Measurement Setup (Figure 2-3)
- Performance Test Record (Table 2-15)
- Self-Test Error Codes/Messages (Table 3-2)
- Troubleshooting Flowcharts (Figures 3-2, 3-5 through 3-9)
- Initialization Program Listing (Figure 3-17)
- Cable and Connector Locations (Figure 3-18)
- Disassembly Procedures for A5 DSP Board (page 3-50)
- Digital Signal Processor (DSP) Board (page 4-14)
- Simplified Power/Control/DSP Circuits (Figure 4-9)
- Parts list (Tables 5-6, 5-7, 5-9 through 5-12)
- Test Points (Table 6-3)
- Schematic Diagrams (Figures 6-5, 6-6, 6-7, 6-10, 6-11, 6-12)

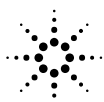

Agilent Technologies

## Table of Contents

Addendum A - SERVICE MANUAL.....	1
Foreword.....	1
Areas of Difference.....	1
Table of Contents.....	2
Chapter 1 Differences.....	3
Chapter 2 Differences.....	3
Test Equipment Required.....	3
Measurement Techniques.....	4
Basic Test Setup.....	4
Voltage and Current Values.....	5
Transient Recovery Time.....	5
CC RMS Noise Measurement Test Setup.....	5
Performance Test Record.....	6
Chapter 3 Differences.....	8
Signature Analysis.....	8
Self-Test Error Codes/Messages.....	8
Overall Troubleshooting (sheet 1).....	9
Overall Troubleshooting (sheet 2).....	10
Overall Troubleshooting (sheet 3).....	11
Overall Troubleshooting – sheet 4.....	12
Overall Troubleshooting (sheet 5).....	13
Flow Charts -.....	13
No Display Troubleshooting.....	14
OV Will Not Fire Troubleshooting.....	15
OV at Turn-On Troubleshooting.....	16
Output Held Low Troubleshooting (sheet 1).....	17
Output Held Low Troubleshooting (sheet 2).....	18
Output Held High Troubleshooting.....	19
Initialization and Factory Preset Replacement Program Listing (sheet 1).....	20
Initialization and Factory Preset Replacement Program Listing (sheet 2).....	21
Initialization and Factory Preset Replacement Program Listing – (sheet 3).....	22
Cable and Connector Locations.....	23
Chapter 4 Differences.....	25
Digital Signal Processor (DSP) Board.....	25
Simplified Diagram of DSP Circuits.....	26
Chapter 5 Differences.....	27
Chapter 6 Differences.....	43
Test Points.....	43
Figure 6-5. A1 Main Board Component Location Coordinates for E4350B.....	47
Figure 6-5. A1 Main Board Assembly Drawing and Test Points for E4350B.....	47
Figure 6-5. A1 Main Board Schematic Diagram for E4350B (sheet 1 of 4).....	47
Figure 6-5. A1 Main Board Schematic Diagram for E4350B (sheet 2 of 4).....	47
Figure 6-5. A1 Main Board Schematic Diagram for E4350B (sheet 3 of 4).....	47
Figure 6-5. A1 Main Board Schematic Diagram for E4350B (sheet 4 of 4).....	47
Figure 6-6. A4 Left Tunnel Circuit Component Locations for E4350B.....	47
Figure 6-6. A4A1/A4A3 Left Tunnel Circuit Schematic Diagrams for E4350B.....	47
Figure 6-7. A4 Right Tunnel Circuit Component Locations for E4350B.....	47
Figure 6-7. A4A2/A4A4 Right Tunnel Circuit Schematic Diagrams for E4350B.....	47
Figure 6-10 A5 DSP Board Test Points.....	47
Figure 6-11 A6 Adapter Board Schematic Diagram.....	47
Figure 6-12 A7 Phone Adapter Board Component Location and Schematic Diagram.....	47

---

## Chapter 1 Differences

### Firmware Revisions

The Agilent E4350B/E4351B SAS firmware resides in the front panel board's ROM chip (A3U4), the GPIB board's ROM chip (A2U106), and in the DSP board's ROM chips (A5U734 and A5U735).

Use the \*IDN query as described in chapter 3 of the Service Manual to get the firmware revision numbers.

---

## Chapter 2 Differences

### Test Equipment Required

**Table 2-2. Test Equipment Required for Verification**

Type	Required Characteristics	Recommended Model
Current Monitor Resistor	15A (0.1 Ohm) +/- 0.04%	Guildline 9230/15
DC Power Supply	5V @ 10A	Agilent 6642A, 6653A
Digital Voltmeter	Resolution: 10 nV @ 1 V Readout: 8 1/2 digits Accuracy: 20 ppm	Agilent 3458A
Electronic Load	Voltage and current range must exceed range of supply under test. Power range: 500 W min.	Agilent 6050A mainframe with Agilent 60504A (60 V) plug-in module, or Agilent 60504A-J10 (120 V) plug-in module.
GPIB Controller	Full GPIB capabilities	HP Series 300
Load Resistor (for CC rms ripple and noise tests)	2 – 16 Ohm 300W (adjusted for 15 Ohm each connected in parallel or series) 1 – 1.6 Ohm 300W	Ohmite E300K16R Ohmite E300K1R6
Oscilloscope	Sensitivity: 1 mV Bandwidth limit: 20 MHz Probe: 1:1 with RF tip	Agilent 54504A
RMS Voltmeter	True rms bandwidth: 20 MHz Sensitivity: 100 uV	Agilent 3400B
Variable-Voltage Transformer	Adjustable from -13% to +6% of input range. Power: 1 kVA min.	Superior Electric 0 to 280 Vac, 7.5 A (226U) 0 to 140 Vac, 15 A (126U)

## Measurement Techniques

**Note** All tests are performed in the **FIXED** as shown in Figure 2-1.

- Measure the DC voltage directly at the +S and -S terminals.
- Set the SENSE switch at the back of the supply to the Remote position.
- Connect the remote sensing leads from +OUT to +S, and from -OUT to -S.
- Use adequate wire gauge for the load leads as described in Chapter 4 of the Operating Manual.

## Basic Test Setup

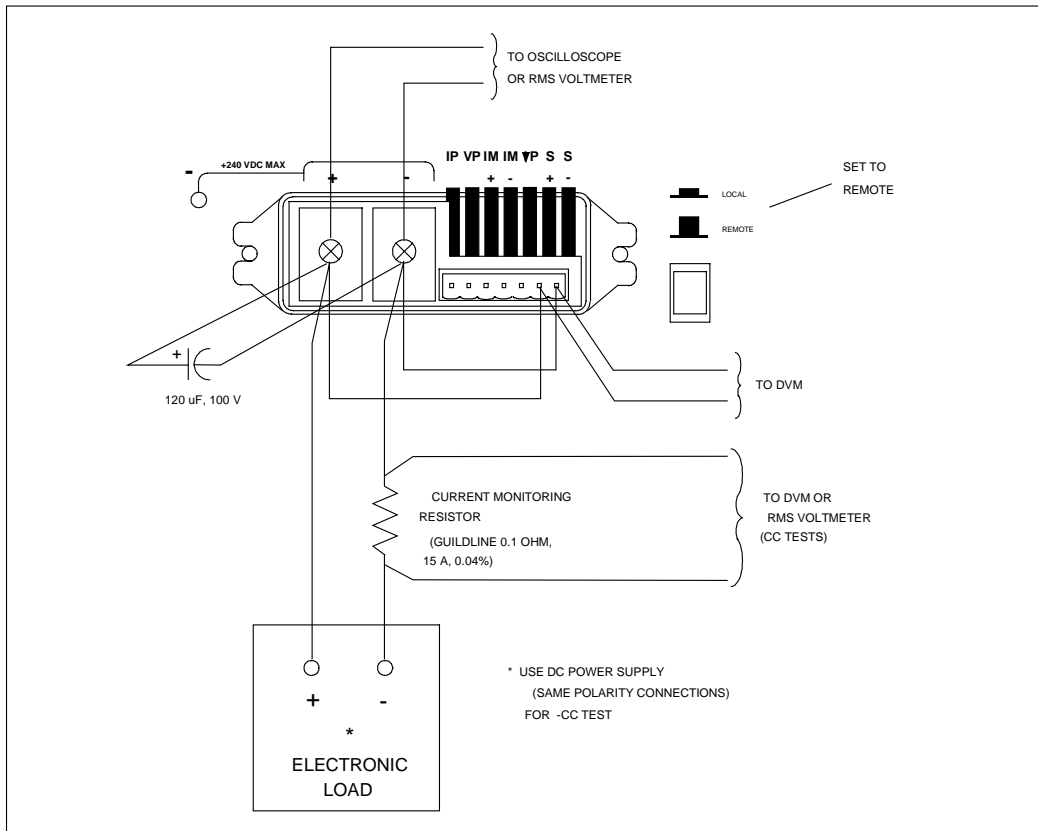

Figure 2-1. Basic Test Setup

## Voltage and Current Values

Table 2-3. Voltage and Current Values

Agilent Model	Full-scale Voltage	Max. Prog. Voltage	Full-scale Current	Max. Prog. Current	Max. Prog. Overvoltage
E4350B	60V	61.5V	8A	8.16A	73.0V
E4351B	120V	123V	4A	4.08A	140V

## Transient Recovery Time

This test does not need to be performed on the Agilent E4350B.

## CC RMS Noise Measurement Test Setup

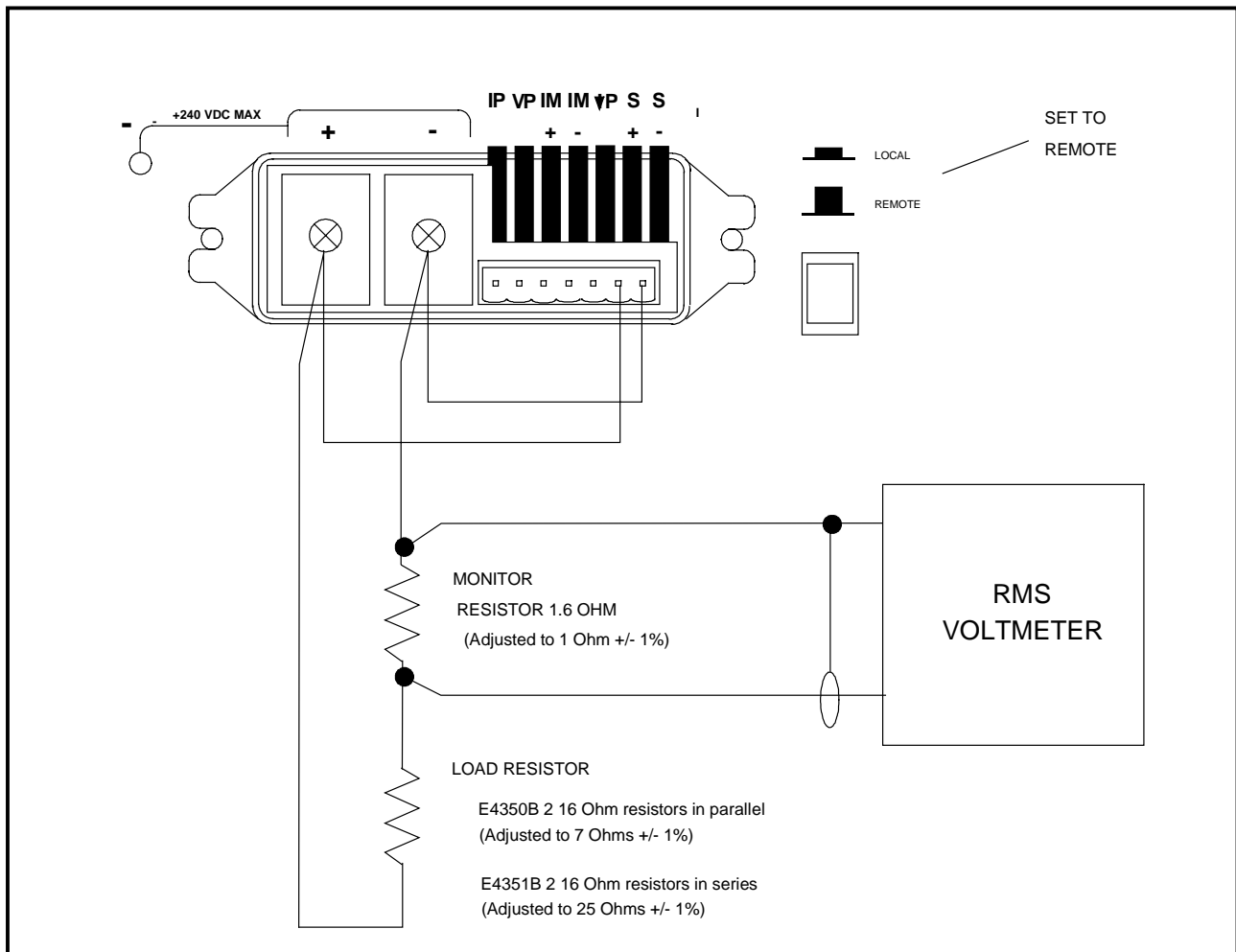

Figure 2-3. CC RMS Noise Measurement Test Setup

## Performance Test Record

Table 2-15A. Performance Test Record for Agilent Model E4350B

Agilent E4350B		Report No. _____		Date _____	
Test Description	Minimum Spec.	Result *	Maximum Spec.	Measurement Uncertainty	
<b>Constant Voltage Tests</b>					
<b>Voltage Programming and Readback Accuracy</b>					
Low Voltage (set to 0V) $V_{out1}$	-10mV	_____ mV	+10mV	1.5 $\mu$ V	
Readback Accuracy	$V_{out1} - 42mV$	_____ mV	$V_{out1} + 42mV$	2 $\mu$ V	
High Voltage (set to 60V) $V_{out2}$	59.945V	_____ V	60.055V	845 $\mu$ V	
Readback Accuracy	$V_{out2} - 90mV$	_____ mV	$V_{out2} + 90mV$	845 $\mu$ V	
<b>Load Effect</b>	-2mV	_____ mV	+2mV	40 $\mu$ V	
<b>Source Effect</b>	-2mV	_____ mV	+2mV	40 $\mu$ V	
<b>PARD (Ripple &amp; Noise)</b>					
Peak to Peak	0	_____ mV	95mV	840 $\mu$ V	
RMS	0	_____ mV	12mV	2.1mV	
<b>Constant Current Tests</b>					
<b>Current Programming and Readback Accuracy</b>					
Low Current (set to 0A) $I_{out1}$	-20mA	_____ mA	+20mA	0.5 $\mu$ A	
Readback Accuracy	$I_{out1} - 28mA$	_____ mA	$V_{out1} + 28mA$	20 $\mu$ A	
High Current (set to 8A) $I_{out2}$	7.956A	_____ A	8.044A	3.3mA	
Readback Accuracy	$I_{out2} - 30mA$	_____ mA	$V_{out2} + 30mA$	3.3mA	
<b>Current Sink (<math>I_{sink} = 1.8A</math>)</b>	$I_{sink} - 48mA$	_____ mA	$I_{sink} + 48mA$	1mA	
<b>Readback Accuracy</b>					
<b>PARD (Ripple &amp; Noise)</b>					
RMS	0	_____ mA	2.4mA	1.8mA	
SAS Mode **					
RMS	0	_____ mA	4mA	270 $\mu$ A	
Peak to Peak	0	_____ mA	32mA	2.6mA	
<b>Load Effect</b>	-1mA	_____ mA	+1mA	3.4 $\mu$ A	
<b>Source Effect</b>	-1mA	_____ mA	+1mA	3.4 $\mu$ A	
<p>* Enter your results in this column</p> <p>** PARD (Optional Test in SAS mode)</p> <p>Program I - V Curve: <math>I_{SC} = 8A</math> <math>I_{MP} = 7.5A</math> <math>V_{MP} = 60V</math> <math>V_{OC} = 65V</math> <math>R_L = 8</math> Ohms.</p> <p>Use Fig 2-3 with scope across monitoring resistor for P-P ripple or RMS voltmeter for RMS.</p>					

**Table 2-15B. Performance Test Record for Agilent Model E4351B**

Agilent E4351B	Report No. _____	Date _____		
Test Description	Minimum Spec.	Result *	Maximum Spec.	Measurement Uncertainty
<b>Constant Voltage Tests</b>				
<b>Voltage Programming and Readback Accuracy</b>				
Low Voltage (set to 0V) $V_{out1}$ Readback Accuracy	-20mV $V_{out1} - 84mV$	_____ mV _____ mV	+20mV $V_{out1} + 84mV$	1.7 $\mu$ V 1.7 $\mu$ V
High Voltage (set to 120V) $V_{out2}$ Readback Accuracy	119.89V $V_{out2} - 180mV$	_____ V _____ mV	120.11V $V_{out2} + 180mV$	1.7mV 1.7mV
<b>Load Effect</b>	- 2mV	_____ mV	+ 2mV	230 $\mu$ V
<b>Source Effect</b>	- 2mV	_____ mV	+ 2mV	230 $\mu$ V
<b>PARD (Ripple &amp; Noise)</b>				
Peak to Peak	0	_____ mV	95mV	3mV
RMS	0	_____ mV	12mV	1.5mV
<b>Constant Current Tests</b>				
<b>Current Programming and Readback Accuracy</b>				
Low Current (set to 0A) $I_{out1}$ Readback Accuracy	- 10mA $I_{out1} - 14mA$	_____ mA _____ mA	+ 10mA $V_{out1} + 14mA$	16 $\mu$ A 16 $\mu$ A
High Current (set to 4A) $I_{out2}$ Readback Accuracy	3.982A $I_{out2} - 22mA$	_____ A _____ mA	4.018A $V_{out2} + 22mA$	0.6mA 0.6mA
<b>Current Sink (0.9A) Readback Accuracy</b>	$I_{sink} - 27mA$	_____ mA	$I_{sink} + 27mA$	120 $\mu$ A
<b>PARD (Ripple &amp; Noise)</b>				
RMS	0	_____ mA	2.4mA	270 $\mu$ A
SAS Mode **				
RMS	0	_____ mA	4mA	270 $\mu$ A
Peak to Peak	0	_____ mA	32mA	2.6mA
<b>Load Effect</b>	- 1mA	_____ mA	+ 1mA	2.2 $\mu$ A
<b>Source Effect</b>	- 1mA	_____ mA	+ 1mA	2.2 $\mu$ A
<p>* Enter your results in this column</p> <p>** PARD (Optional Test in SAS mode)</p> <p>Program I – V Curve: <math>I_{SC} = 4A</math> <math>I_{MP} = 3.75A</math> <math>V_{MP} = 120V</math> <math>V_{OC} = 130V</math> <math>R_L = 32</math> Ohms.                      Use Fig 2-3 with scope across monitoring resistor for P-P ripple or RMS voltmeter for RMS.</p>				

## Chapter 3 Differences

### Signature Analysis

Signature analysis (SA) troubleshooting for the secondary circuits on the A1 main circuit board is ++NOT++ available for the Agilent E4350B unit. However, GPIB and front panel signature analysis is available as described in chapter 3 of the Service Manual.

### Self-Test Error Codes/Messages

**Table 3-2. Self-Test Error Codes/Messages**

Code/Message	Description	Probable Cause
E1 FP RAM	Front panel RAM test failed	Microprocessor A3U3 defective
E2 FP ROM	Front panel ROM test failed	ROM A3U4 or address latch A3U8 defective
E3 EE CHKSUM	Front panel EEPROM checksum failed	Possibly due to power loss during a write operation. See checksum Error Recovery on page 3-3 in the Operating manual. If power loss is not the problem, EEPROM A3U6 could be defective (after replacing U6, supply must be initialized and calibrated).
E4 PRI XRAM	Primary interface external RAM test failed	A2 GPIB board defective
E5 PRI IRAM	Primary interface internal RAM test failed	A2 GPIB board defective
E6 PRI ROM	Primary interface DOM test failed	A2 GPIB board defective
E7 GPIB	GPIB interface test failed	Talker/Listener chip A2U117 defective
E8 SEC RAM	Secondary interface RAM test failed	A5 DSP board defective
E9 SEC ROM	Secondary interface ROM test failed	A5 DSP board defective
E10 SEC 5 V	Secondary interface 5 volt readback test failed	A5 DSP board defective
E11 TEMP	Ambient temperature readback test failed	A5 DSP board defective
E12 DACS	CV or CC DAC test failed	A5 DSP board defective
E30 SEC DAC	Secondary interface DAC test failed	A5 DSP board defective
E31 SEC DAC	Secondary interface DAC test failed	A5 DSP board defective
E32 SEC DAC	Secondary interface DAC test failed	A5 DSP board defective
E45 SEC IO	Secondary interface I/O test failed	A5 DSP board defective
E46 SEC NVRAM	Secondary interface nonvolatile RAM test failed	A5 DSP board defective
<b>Note:</b> The following error messages can appear due to a failure occurring either while the power supply is operating or during self test.		
SERIAL TIMEOUT	Serial data line failure on GPIB board	A2 GPIB board defective
SERIAL DOWN	Serial data line failure on GPIB board	A2 GPIB board defective
UART PARITY	Uart failed on GPIB board	A2 GPIB board defective
UART FRAMING	Uart failed on GPIB board	A2 GPIB board defective
UART OVERRUN	Uart failed on GPIB board	A2 GPIB board defective
SBUF OVERRUN	Serial buffer failure on GPIB board	A2 GPIB board defective
SBUF FULL	Serial buffer failure on GPIB board	A2 GPIB board defective
STK OVERFLOW	Stack overflow failure on DSP board	A5 DSP board defective
EE WRITE ERR	EEPROM write failure on front panel board	EEPROM A3U6 defective or calibration error
SECONDARY DN	Serial data line failure on DSP board	A5 DSP board defective



# Overall Troubleshooting (sheet 1)

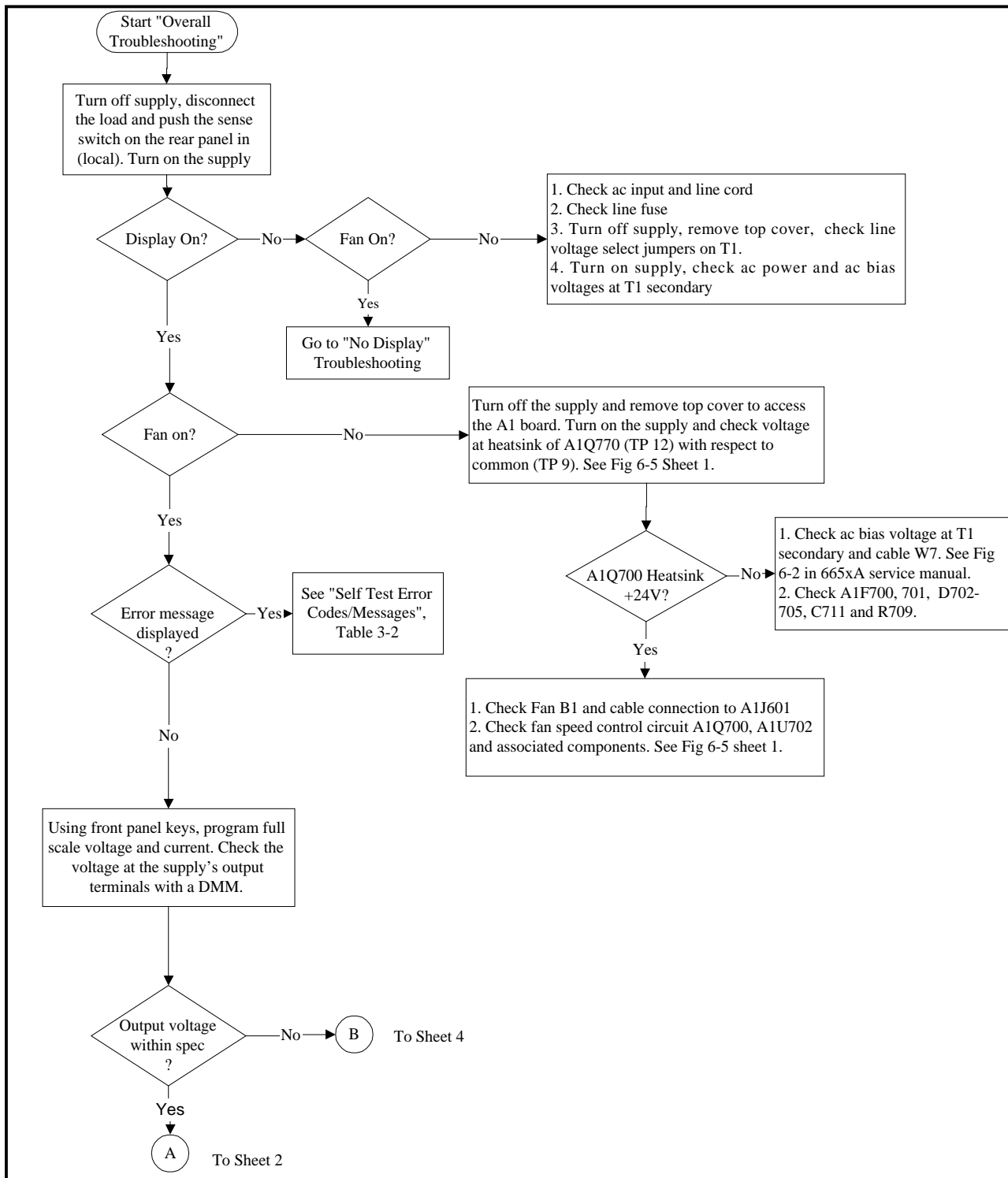

Figure 3-2. Overall Troubleshooting (sheet 1 of 5)

## Overall Troubleshooting (sheet 2)

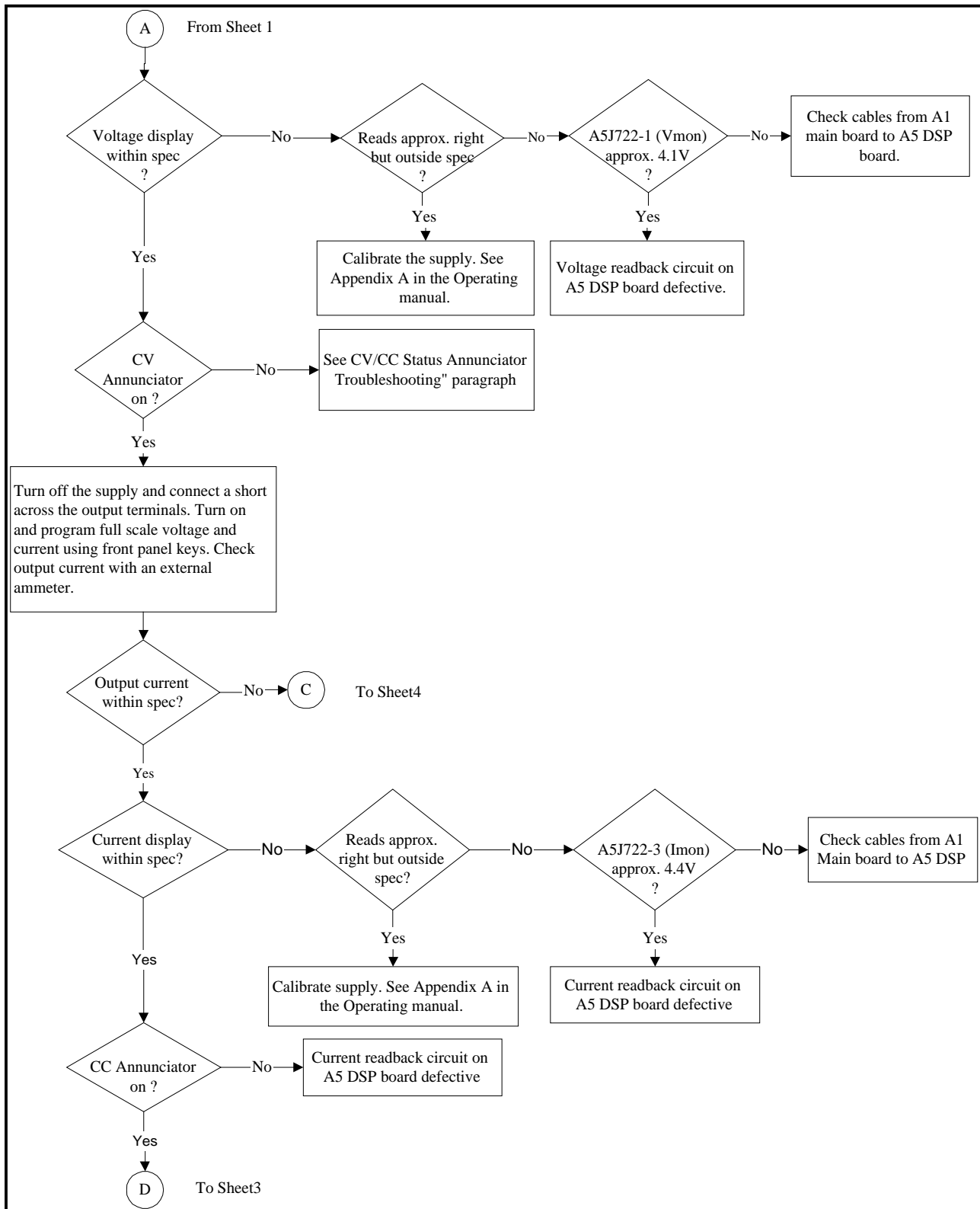

Figure 3-2. Overall Troubleshooting (sheet 2 of 5)

## Overall Troubleshooting (sheet 3)

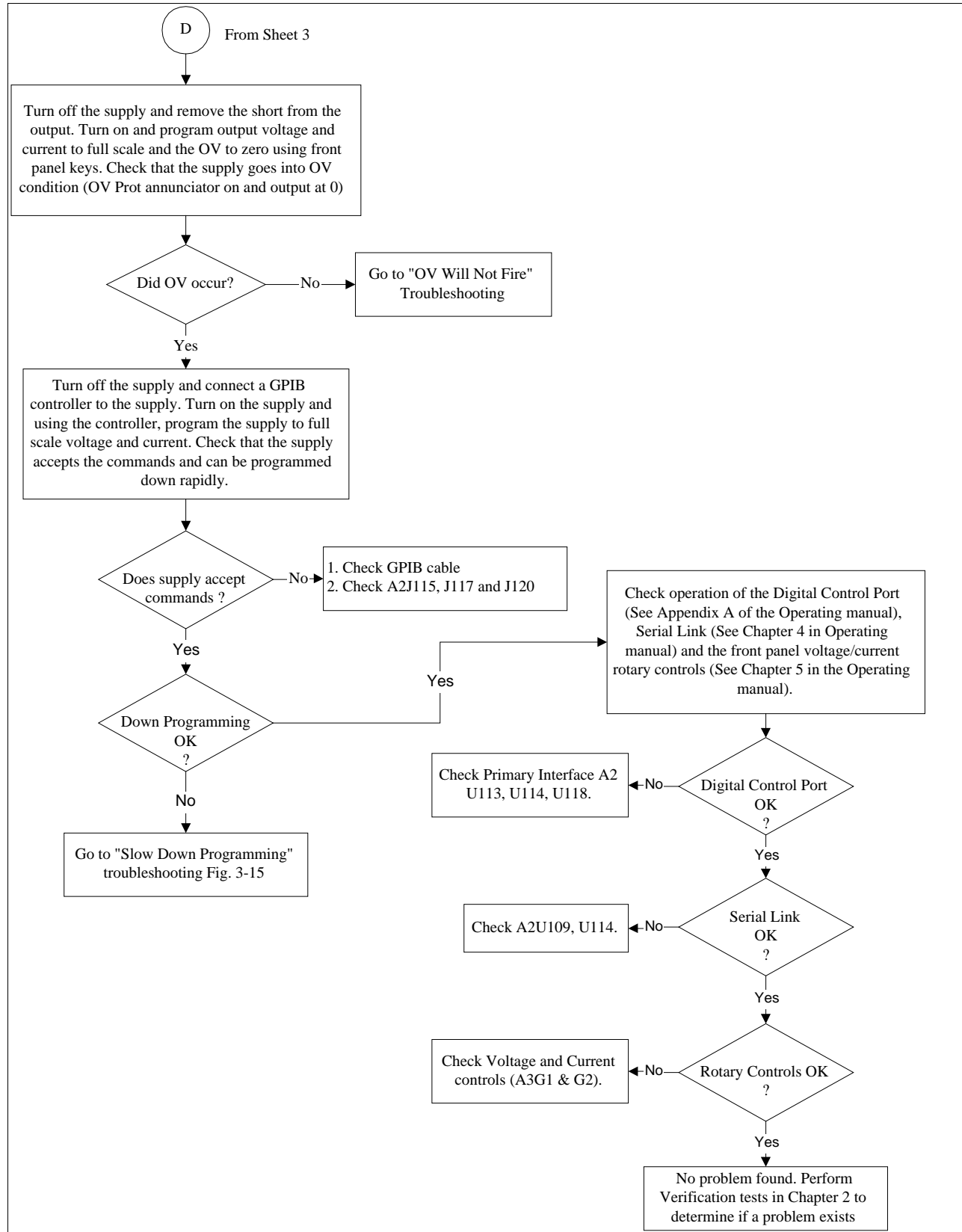

Figure 3-2. Overall Troubleshooting (sheet 3 of 5)

# Overall Troubleshooting – sheet 4

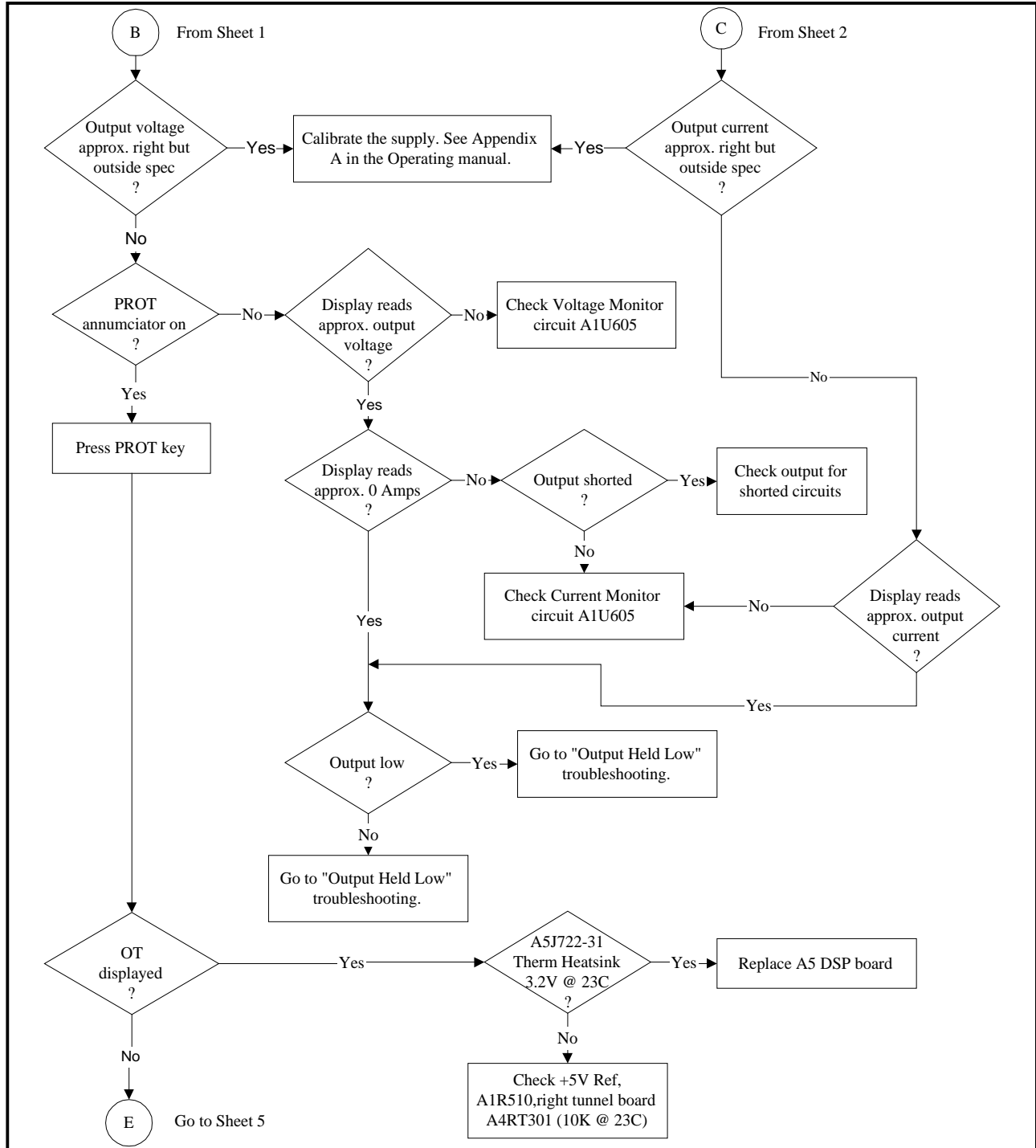

Figure 3-2. Overall Troubleshooting (sheet 4 of 5)

## Overall Troubleshooting (sheet 5)

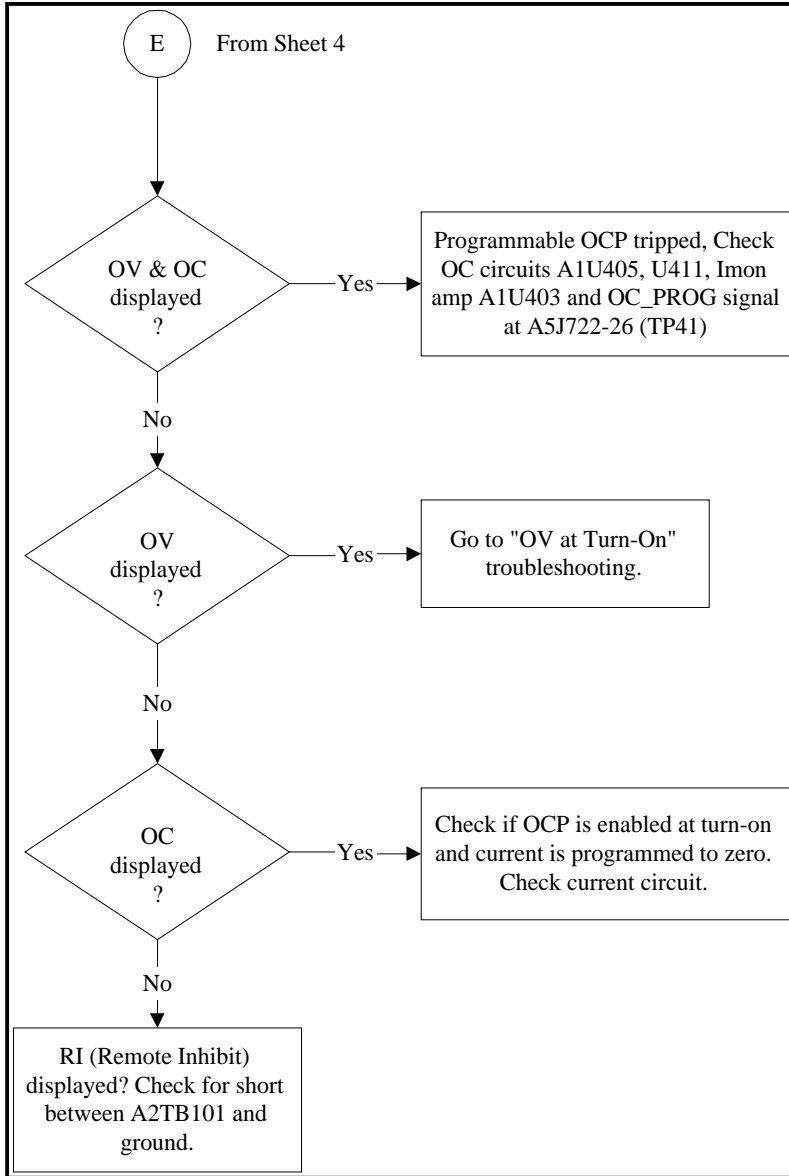

Figure 3-2. Overall Troubleshooting (sheet 5 of 5)

### Flow Charts -

The flow charts shown in Figures 3-10 through Figures 3-14 and Figure 3-16 are not used in troubleshooting the Solar Array Simulator.

Note that there are no changes to the flow chart in Figure 3-15.

## No Display Troubleshooting

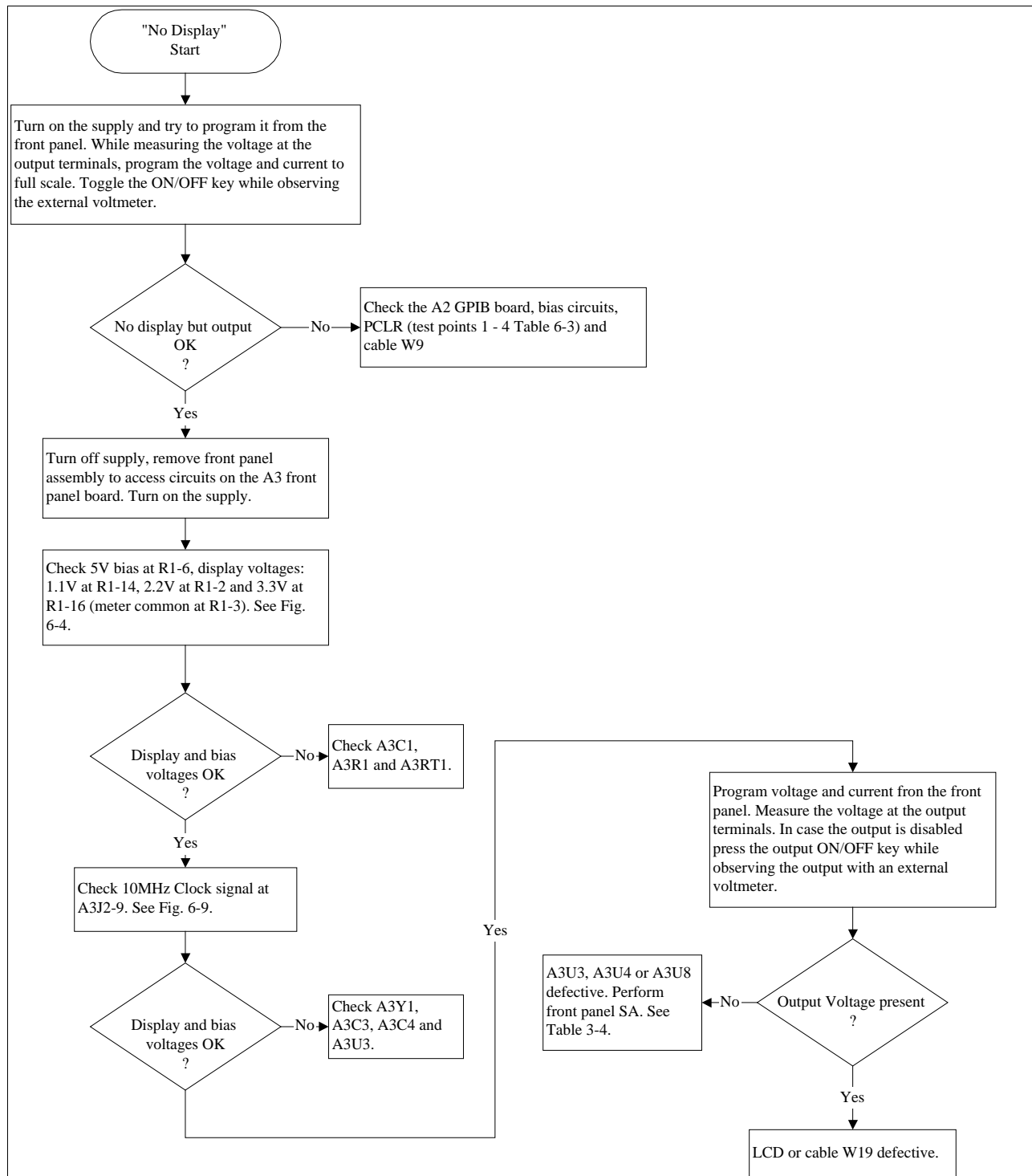

Figure 3-5. No Display Troubleshooting

## OV Will Not Fire Troubleshooting



Figure 3-6. OV Will Not Fire Troubleshooting

## OV at Turn-On Troubleshooting

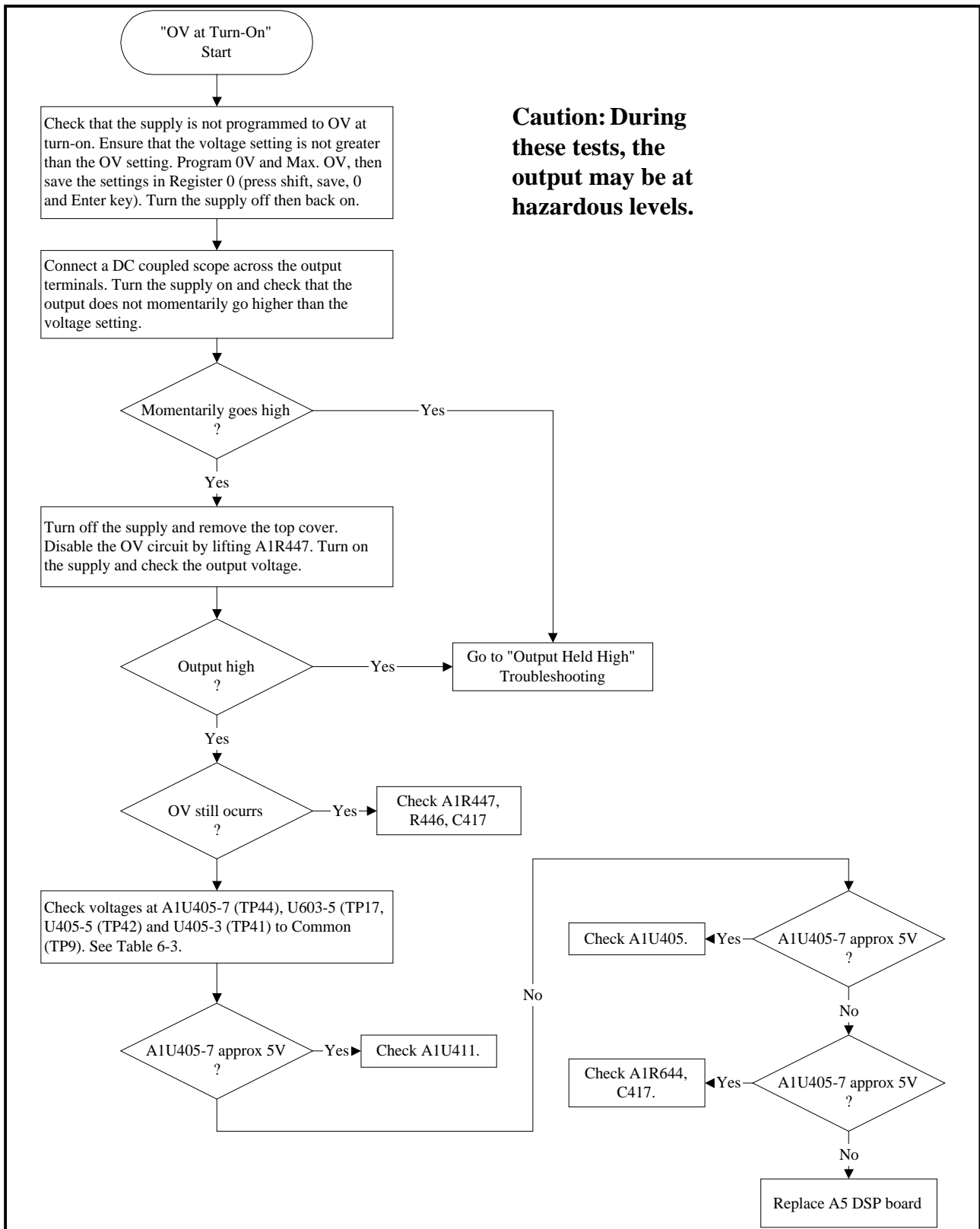

Figure 3-7. OV at Turn-on Troubleshooting



## Output Held Low Troubleshooting (sheet 1)

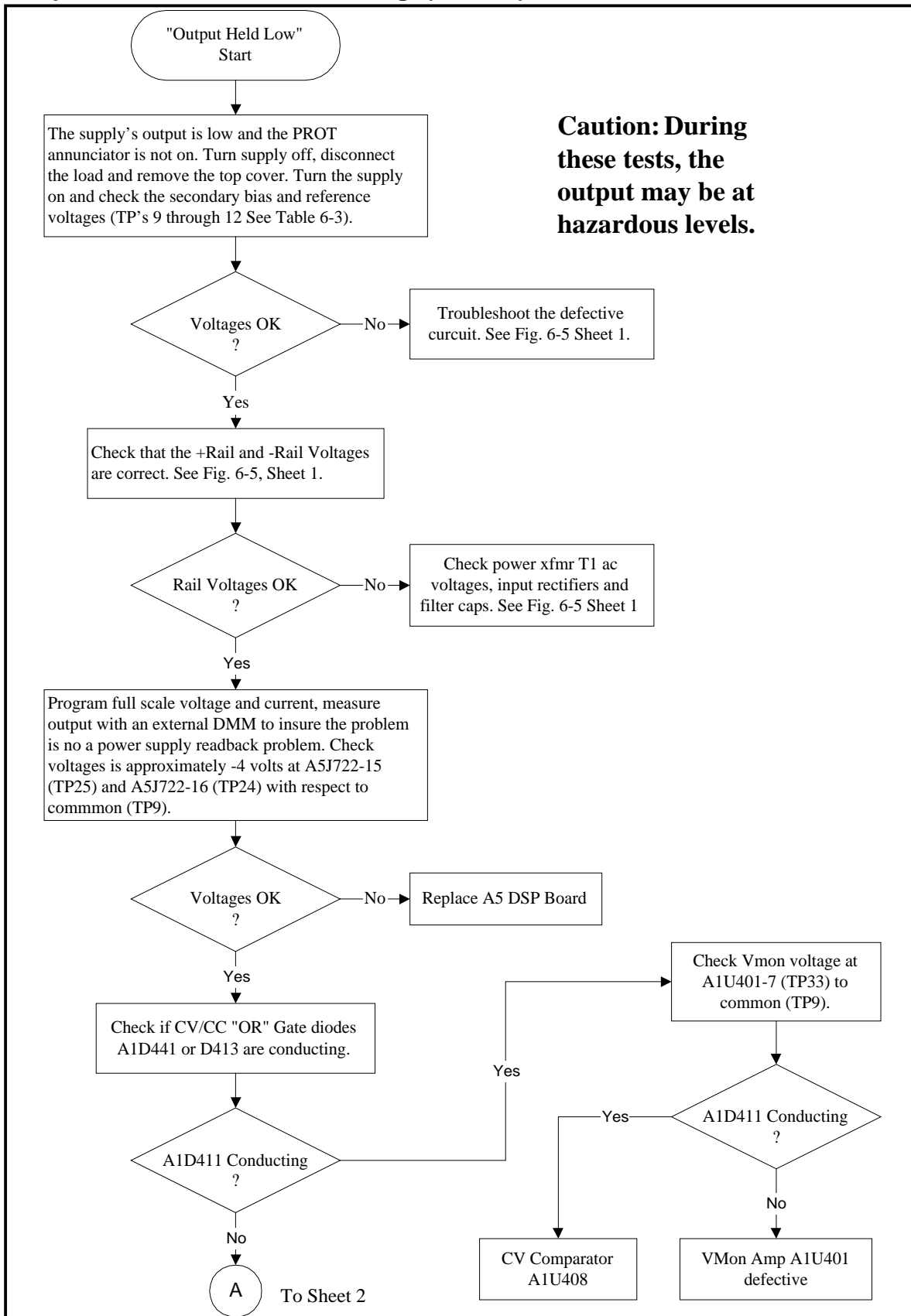

Figure 3-8 Output Held Low Troubleshooting (Sheet 1 of 2)

## Output Held Low Troubleshooting (sheet 2)

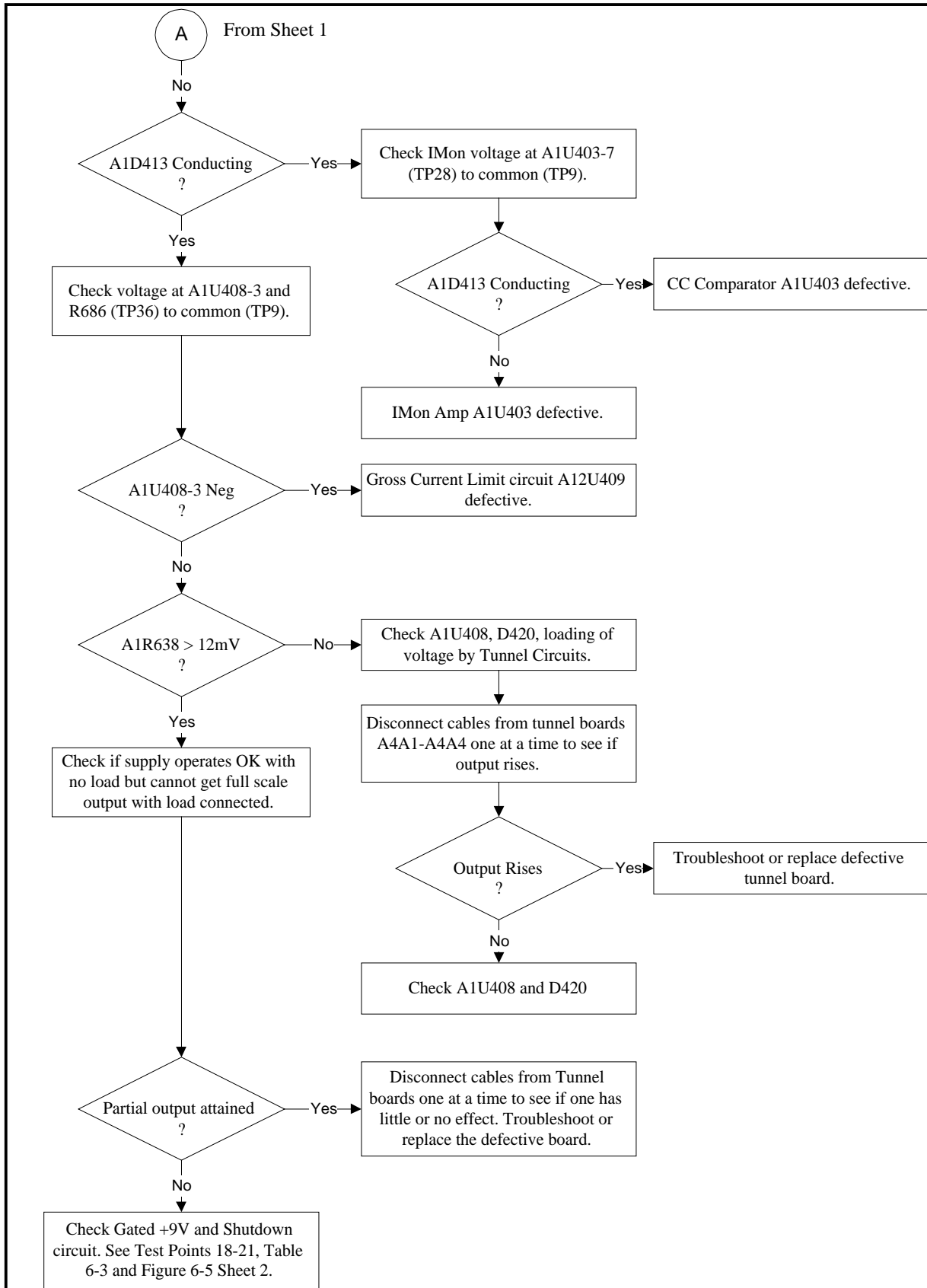
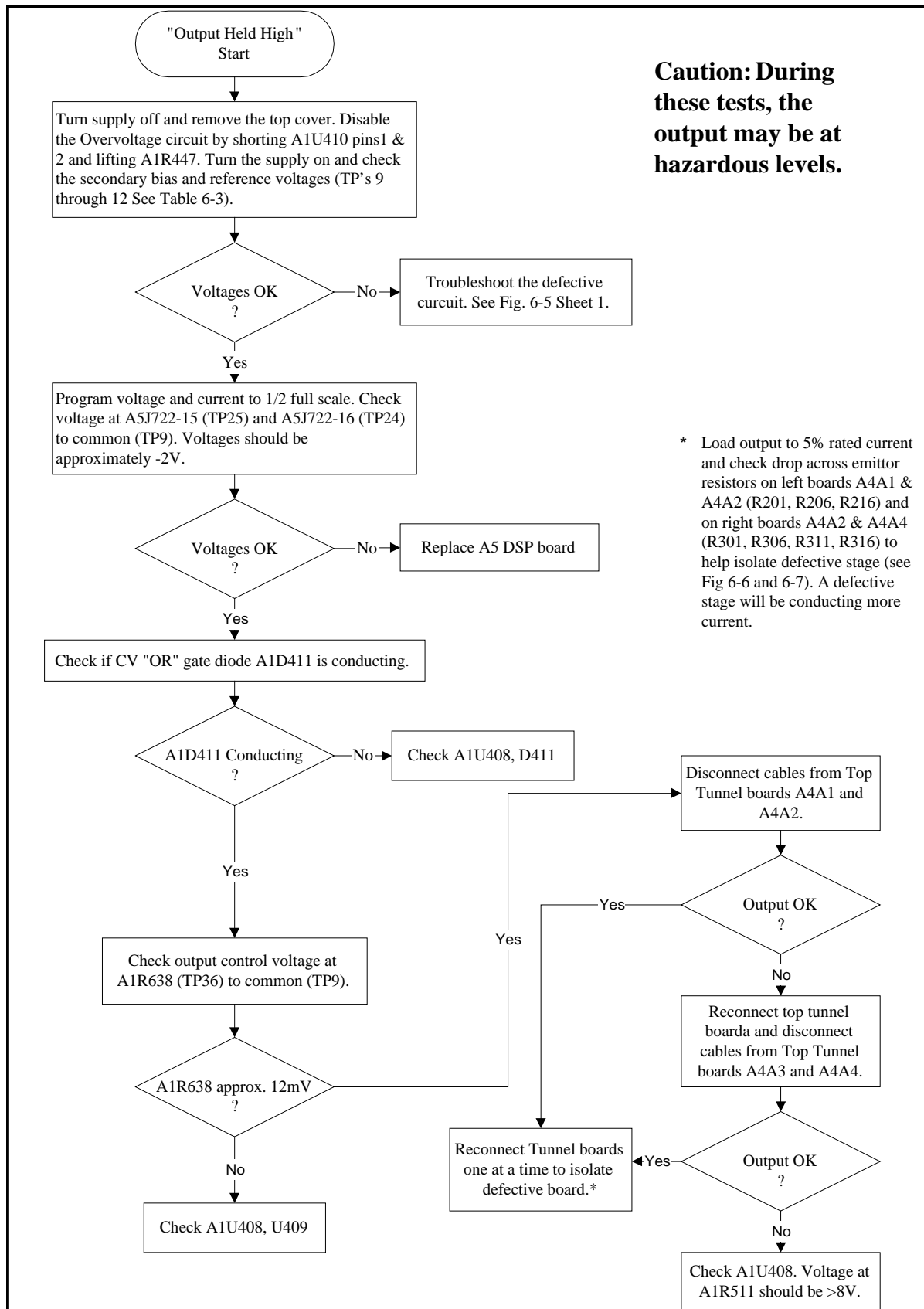

Figure 3-8 Output Held Low Troubleshooting (Sheet 2 of 2)

## Output Held High Troubleshooting



**Caution: During these tests, the output may be at hazardous levels.**

\* Load output to 5% rated current and check drop across emitter resistors on left boards A4A1 & A4A2 (R201, R206, R216) and on right boards A4A2 & A4A4 (R301, R306, R311, R316) to help isolate defective stage (see Fig 6-6 and 6-7). A defective stage will be conducting more current.

Figure 3-9. Output Held High Troubleshooting

## Initialization and Factory Preset Replacement Program Listing (sheet 1)

```
10 ! Program to initialize EEPROM data in Models E4350B and E4351B
20 ! RE-STORE "INIT_435X"
30 ! Rev A.00.00 dated Nov, 17,1998
40 !
50 DIM Init_data(1:49),Model${6},Idn${21}
60 INTEGER Addr(1:49),Length(1:49)
70 ASSIGN @Ps TO 705 ! Supply must be at address 705
80 CLEAR SCREEN
90 !
100 Eprom_data_addr: ! Data address
110 DATA 2,6,10,14,18,19,20,24,28,32
120 DATA 36,37,38,42,46,50,54,55,56,57
130 DATA 64,68,72,76,80,84,88,92,96,100
140 DATA 136,137,138,139,140,142,146,148,149,150
150 DATA 151,152,153,154,155,156,157,158,160
160 !
170 Eprom_data_len: ! Data for word length
180 DATA 4,4,4,4,1,1,4,4,4,4
190 DATA 1,1,4,4,4,4,1,1,1,1
200 DATA 4,4,4,4,4,4,4,4,4,4
210 DATA 1,1,1,1,2,4,2,1,1,1
220 DATA 1,1,1,1,1,1,1,2,1
230 !
240 Eprom_data_50B: ! EEPROM data for E4350B
250 DATA 56.71,76.42,61.5,0,82,0,409.6,148.05,8.16,0
260 DATA 99,3,9.321,27,73,0,83,255,20,10
270 DATA 4350,54.39,167,436.44,167,0,10.0,10.0,65,1600
280 DATA 5,255,0,0,17,4350,0,20,160,20
290 DATA 160,156,37,98,115,15,20,0,96
300 !
310 Eprom_data_51B: ! EEPROM data for E4351B
320 DATA 28.36,40.96,123.0,0,0,82,0,819.2,283.57,4.08,0
330 DATA 99,3,5.121,27,140,0,83,255,20,10
340 DATA 4351,27.19,167,872.89,167,0,5.0,5.0,130,400
350 DATA 5,255,0,0,17,4351,0,20,160,20
360 DATA 160,156,37,98,115,15,20,0,96
370 !
380 RESTORE Eprom_data_addr
390 !
400 FOR I=1 TO 49
410 READ Addr(I)
420 NEXT I
430 !
440 RESTORE Eprom_data_len
450 !
460 FOR I=1 TO 49
470 READ Length(I)
480 NEXT I
490 !
500 INPUT "Input the model number (i.e. E4350B)",Model${
```

Figure 3-17. Initialization and Factory Preset Replacement Program Listing (Sheet 1 of 3)

## Initialization and Factory Preset Replacement Program Listing (sheet 2)

```
510 CLEAR SCREEN
520 !
530 SELECT Model$
540   CASE "E4350B"
550     RESTORE Eprom_data_50B
560   CASE "E4351B"
570     RESTORE Eprom_data_51B
580   CASE ELSE
590     DISP "Error in Model number, must be E4350B or E4351B."
600     STOP
610 END SELECT
620 !
630 FOR I=1 TO 49                                ! Read model dependent data
640   READ Init_data(I)
650 NEXT I
660 !
670 OUTPUT @Ps;"*CLS"                            ! Clears power supply registers
680 !
690 OUTPUT @Ps;"CAL:STATE ON,"                  ! Turn on cal mode, "0" passcode
700 !
710 GOSUB Ps_error                              ! Error if passcode is not "0"!
720 IF Err THEN
730   OUTPUT @Ps;"*IDN?"                        ! Get data from model # location
740   ENTER @Ps;Idn$
750   Model=VAL(Idn$[POS(Idn$,"")+2])
760 ELSE
770   GOTO Start
780 END IF
790 !
800 OUTPUT @Ps;"CAL:STATE ON,";Model            ! Turn on cal mode, passcode =
810                                           ! data at model number location
820 !
830 GOSUB Ps_error                              ! Error if passcode is not same as
840                                           ! data at model # location
850 IF Err THEN
860   OUTPUT @Ps;"CAL:STATE ON,";Model$[1,4]    ! Turn on cal mode, passcode =
870                                           ! model #
880   GOSUB Ps_error
890   IF Err THEN
900     PRINT "Change pass code to the power supply model # or zero then restart the program."
910     STOP
920   ELSE
930     GOTO Start
940   END IF
950 END IF
960 !
970 Start: !
980   !
990 CLEAR SCREEN
1000 PRINT "Initializing EEPROM"
```

Figure 3-17. Initialization and Factory Preset Replacement Program Listing (Sheet 2 of 3)

### Initialization and Factory Preset Replacement Program Listing – (sheet 3)

```
1010 !
1020 FOR I=1 TO 49
1030   OUTPUT @Ps;"DIAG:EEPR ";Addr(I);";";Length(I);";";Init_data(I)
1040 NEXT I
1050 !
1060 CLEAR SCREEN
1070 OUTPUT @Ps;"CAL:STATE OFF"           ! Turn off cal mode
1080 !
1090 GOSUB Ps_error                       ! Check for errors
1100 IF Err THEN
1110   PRINT "An error occurred during the EEPROM read/write, Check for"
1120   PRINT "programming errors. Initialization data may be incorrect."
1130   STOP
1140 END IF
1150 !
1160 PRINT "Operation complete. Program stopped."
1170 STOP
1180 !
1190 Ps_error:                            ! Error handling subroutine
1200 OUTPUT @Ps;"SYST:ERR?"             ! Check for errors
1210 ENTER @Ps;Err
1220 RETURN
1230 !
1240 END
```

Figure 3-17. Initialization and Factory Preset Replacement Program Listing (Sheet 3 of 3)

### Cable and Connector Locations

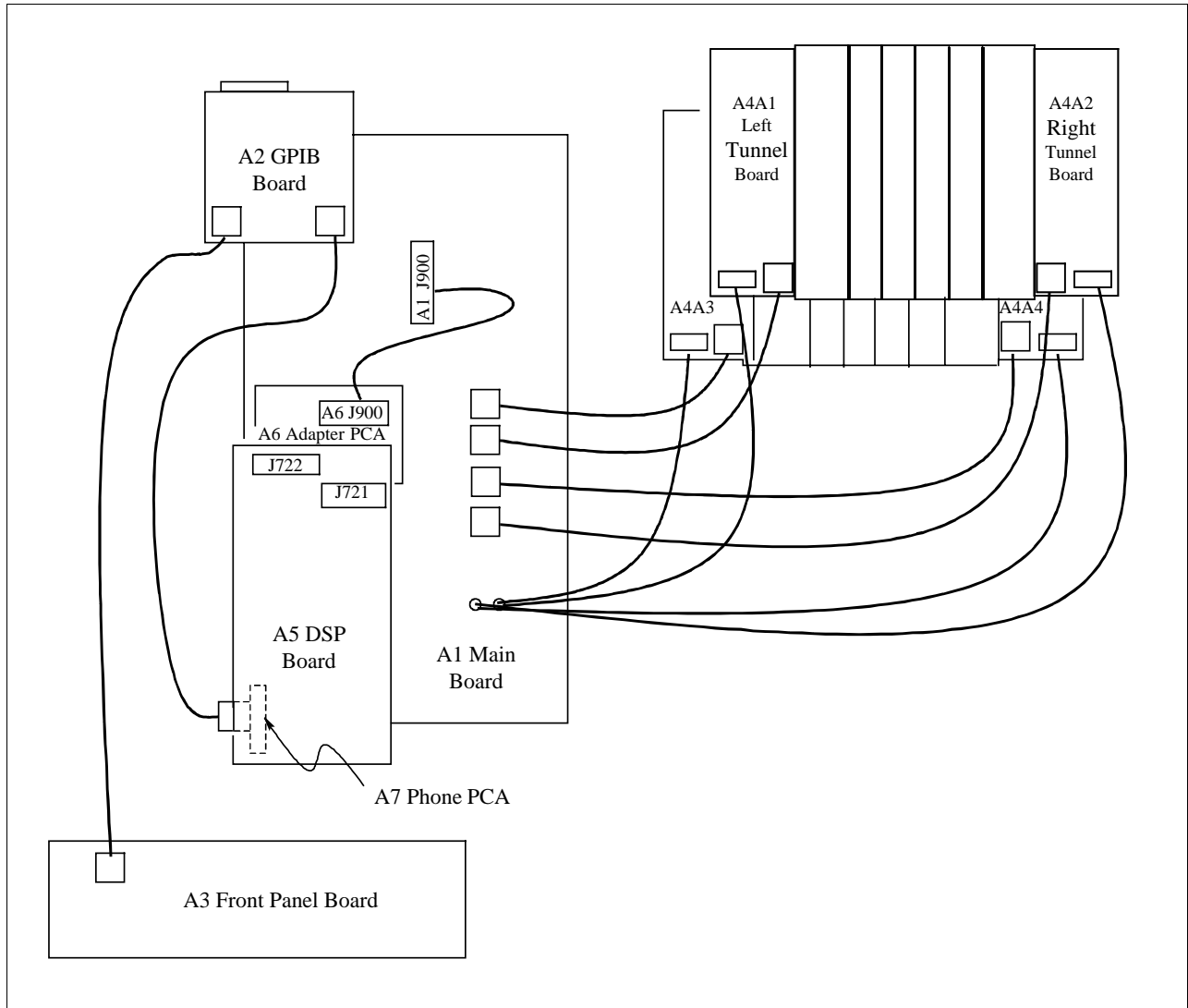

Figure 3-18. Cable and Connector Locations for E4350B/E4351B

## DSP Board

To remove the A5 DSP Board, proceed as follows:

- Remove the top cover of the power supply as described under, "Top Cover Removal and Replacement."
- Remove the six screws that attach the cover to the DSP board (use a T10 TORX drive).
- Disconnect both cables going to the GPIB board.

---

**Note** Be sure to mark any or all cables prior to removal so that no mistake is made later when reinstalling these cables.

---

- Disconnect the ribbon cable located at the end of the DSP board.
- Remove the two screws that attach the DSP board to the left side of the chassis (Use a T10 TORX drive).
- Lift the DSP board together with its mounting bracket out of the chassis.
- Disconnect the cable going to the front panel board.
- Turn the DSP board over and remove the screws that attach the DSP board to the mounting bracket.



---

## Chapter 4 Differences

### Digital Signal Processor (DSP) Board

The DSP board replaces the Secondary Interface section of the A1 Main PC board. It replaces the Secondary Microprocessor (U504), the CV and CC programming DACs, Readback D/A, DAC Reference, Readback Comparators, and the Fan and Overvoltage PWMs. It replaces everything found in Figure 6-5, sheet 3 plus the OV filter/buffer (U603) found on sheet 2.

The DSP board contains the new Secondary Microprocessor circuits, the CV, CC, OV, OC and Fan DAC's, The readback circuits and the secondary ROM and RAM. When operating in the Fixed mode, the instrument acts like a normal power supply with typical crossover characteristics between CV and CC operation. When in SAS mode the customer specified I/E operating curve is entered into the secondary RAM where it is used to modify the supply's crossover characteristics.

Troubleshooting is to be performed in the Fixed (turn-on default) mode only. See Figure 6-10 for the A5J721/A5J722 connector DAC and Bias voltage pin-outs.

---

**Note** The DSP board is available as a replacement assembly only. It is not intended to be repaired to the component level.

---

The following figure is a simplified diagram that shows the circuits located on the DSP board (also referred to as the Secondary Interface) in relation to the Output Power and Control circuits previously discussed in chapter 4.

# Simplified Diagram of DSP Circuits

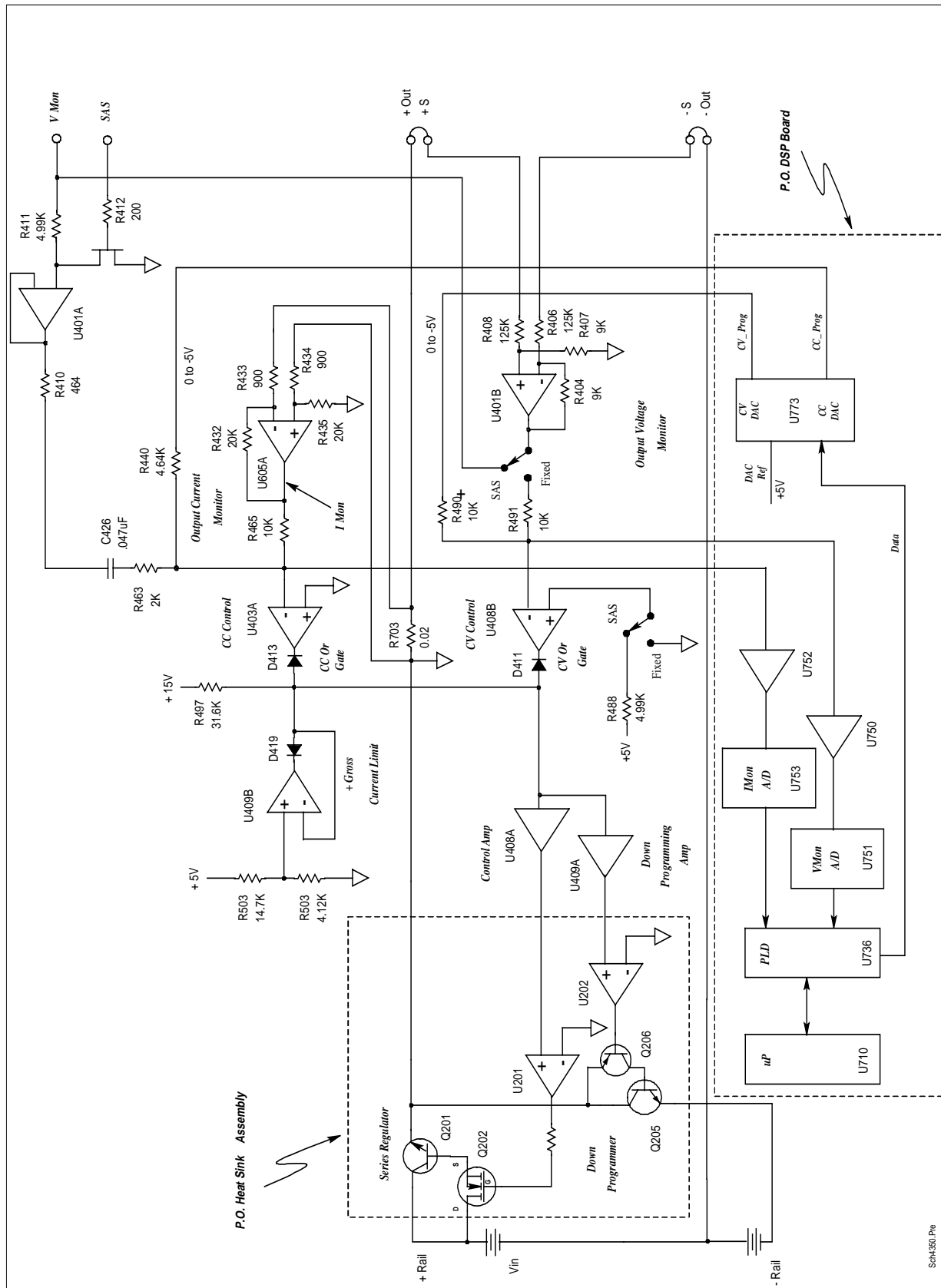

Figure 4-9. Simplified Power/Control/DSP Circuits

## Chapter 5 Differences

Table 5-6. Parts List for E4350B/E4351B Chassis

Reference Designator	Model	Part Number	Description
A1	E4350B	E4350-61024	Main PC Board
A1	E4351B	E4351-61021	Main PC Board
A2		5063-4851	GPIB Board
A3		5063-2360	Keypad/Front Panel PC Board
A4A2 & A4A4		5063-4816	Right Tunnel PCA
A4A1		5063-4818	Left Top Tunnel PCA
A4A3		5063-4820	Left Bottom Tunnel PCA
A5		5063-4811	DSP Board
A6		5063-4852	Access Panel PCA
A7		5063-4813	Phone PCA
W1A		06652-80006	Cable-Assembly, AC #1
W1B		06652-80007	Cable-Assembly, AC #2
W2		06654-80001	Cable-Assembly, Xfmr
W3		06654-80003	Cable-Assembly, Rail
W7		06652-80009	Cable Assembly, AC Bias
W8		06652-80008	Cable, GPIB Bias
W9		06652-80011	Cable-Phone, A2 to L Tunnel
W10		5080-2168	Cable-Phone, A2 to A3
W11, 15		06652-80010	Cable-Phone, A1 to L Tunnel
W13, 17		06652-80011	Cable-Phone, A1 to R Tunnel
W12, 16		06652-80001	Cable-Assembly, A1 to L Tunnel
W14, 18		06652-80002	Cable-Assembly, A1 to R Tunnel
W19		5080-2261	Cable-Assembly, LCD
W20		5080-2419	Ribbon Cable, A1 to A6
<b>Chassis –Mechanical</b>			
Front Panel Logo		E4350-80003	Nameplate E4350B
Front Panel Logo		E4351-80002	Nameplate E4351B
Ref J690		0360-2191	Cover-Term Block
Ref G1, G2		0370-1091	Knob-Base Round
Ref Rmt/Lcl Switch		0370-2862	Pushbutton
Ref GPIB Connector		0380-644	Threaded Stud
Ref Front Frame		0515-0374	Screw-M3x0.5
		0515-0375	Screw-Machine
Ref Cover PCB, A5 Board		0515-0380	Screw-M4x0.7
		0515-0382	Screw-Machine
Ref Xfmr Bracket		0515-0413	Screw-M4x0.7
Ref Term Block Cover		0515-1085	Screw-Machine
Ref Top Cover		0515-1132	Screw-M5x0.8
		0515-1455	Screw-Thd Rlg
Ref A5 Cover, A6 Board		0515-0430	Screw-Torx #10
Ref Fan Top Shroud		0535-0031	Nut-Hex W/Lkwr
Ref Shroud To Base, AC Gnd		0535-0082	Nut-Hex
Ref Display		0590-0534	Nut, Self Thd
		06652-00004	Cover, Top
Ref Heatsink		06652-00008	Heatsink Shroud
Ref A4 Top & Bottom		06652-20001	Heatsink
Ref T1		06652-60005	Jumper Assembly

**Table 5-6. Parts List for E4350A Chassis-Mechanical (continued)**

<b>Reference Designator</b>	<b>Part Number</b>	<b>Description</b>
Ref Display	1000-0842	Window
Ref A2TB101	1252-1488	Terminal Block, 4-Pos
Ref A1J640	1252-3698	Connector
Ref Ac Bias, Tunnel Cables	1400-0493	Cable Tie
Ref Front Bracket	1400-0528	Mount-Cable Tie
Ref Ac Pwr, Tunnel	1400-1281	Clip-Cable
Ref Rear Panel Ground	1510-0044	Binding Post-Single
Ref GPIB Board	1531-0309	Clevis
Ref F450	2110-0927	Fuseholder-W/Cap
	2190-0016	Washer-Lk Intl T
	2190-0034	Washer-Lk Hlcl
Ref AC Ground	2190-0646	Washer-Lock
	2950-0043	Nut-Hex-Dbl-Cham
Ref GPIB Connector	3050-0849	Washer-FI Mtlc
	5001-0539	Trim-Sides
	5001-6734	Front Panel
	5001-6740	Bracket-GPIB
	5001-6748	Front Panel
	5001-6771	Rear Panel
	5001-9819	Chassis
	5040-1665	Keypad
	5040-1666	Heat Sink-Rail
	5040-1667	Heat Sink-Bumper
	5040-1697	Block-Top Cover
	5040-1703	Front Frame
	5041-8801	Foot
	5041-8819	Cap-Strap Handle, Front
	5041-8820	Cap-Strap Handle, Rear
	5062-3704	Strap Handle
Ref Serial Link Cable	5080-2148	Cable, Chain-2m.
	5959-3376	Guide, Service
	5960-5597	Guide, Programming
	5961-2579	Guide, Operating
	5962-8206	SAS Operating Guide
Ref A5 DSP Board	E4350-00001	Bracket-Mounting
Ref A5 DSP Board	E4350-00002	Cover
Front Panel Logo	E4350-80003	Nameplate E4350B
Front Panel Logo	E4351-80002	Nameplate E4351B

**Table 5-7. Parts List for Main PC Board Assembly (A1)**

<b>Reference Designator</b>	<b>Model</b>	<b>Part Number</b>	<b>Description</b>
A1	E4350B	E4350-61024	Main Board – Electrical
A1	E4351B	E4351-61021	Main Board – Electrical
C401	E4350B	0160-4835	Capacitor .1uF 10% 50V
C401	E4351B	0160-4834	Capacitor.047UF 10%
C402	E4350B	0160-4835	Capacitor .1uF 10% 50V
C402	E4351B	0160-4834	Capacitor.047UF 10%
C403	E4350B	0160-4807	Capacitor 33pF 5% 100V
C404	E4350B	0160-4807	Capacitor 33pF 5% 100V
C405		0160-5422	Capacitor.047 uF 20%
C406		0160-4812	Capacitor 220 pF 5%
C407		0160-5422	Capacitor .047 uF 20%
C408		0160-5422	Capacitor .047 uF 20%
C409		0160-4800	Capacitor 120pF 5%
C410		0160-4800	Capacitor 120pF 5%
C411		0160-5422	Capacitor .047 uF 20%
C412		0160-4800	Capacitor 120pF 5%
C413		0160-4800	Capacitor 120pF 5%
C414		0160-6616	Capacitor 6800pF 100V
C415		0160-5909	Capacitor 0.047uF 50 V
C416		0160-5422	Capacitor .047 uF 20%
C417		0160-4812	Capacitor 220pF 5%
C418		0160-4831	Capacitor 4700pF 10%
C419		0160-4831	Capacitor 4700pF 10%
C420		0160-4812	Capacitor 220pF 5%
C421		0160-5098	Capacitor .22uF 10%
C422		0180-4129	Capacitor 1uF 35V
C423	E4350B	0160-5422	Capacitor .047 uF 20%
C424		0160-5422	Capacitor .047 uF 20%
C425		0160-5422	Capacitor .047 uF 20%
C426		0160-5909	Capacitor 0.047uF 50 V
C427		0160-5909	Capacitor 0.047uF 50 V
C428	E4350B	0160-4812	Capacitor 220pF 5%
C428	E4351B	0160-4808	Capacitor470PF 100V
C429		0160-5422	Capacitor.047 uF 20%
C430		0160-4833	Capacitor .022uF 10%
C432		0160-4831	Capacitor 4700pF 10%
C434		0160-5644	Capacitor .033 uF 10%
C435	E4350B	0160-5644	Capacitor .033 uF 10%
C436		0160-5469	Capacitor 1uF 10% 50V
C437		0160-6616	Capacitor 6800pF 100V
C439		0160-4831	Capacitor 4700pF 10%
C440	E4350B	0160-4833	Capacitor .022uF 10%
C440	E4351B	0160-4832	Capacitor.01UF 10%
C441		0160-5422	Capacitor .047 uF 20%
C442		0160-5422	Capacitor .047 uF 20%
C443	E4350B	0160-5422	Capacitor .047 uF 20%
C445		0160-4807	Capacitor 33pF 5% 100V
C446		0160-4801	Capacitor 100pF 5%
C447		0160-4805	Capacitor 47pF 5% 100V

**Table 5-7. Parts List for Main PC Board Assembly A1 (Continued)**

<b>Reference Designator</b>	<b>Model</b>	<b>Part Number</b>	<b>Description</b>
C448		0160-5422	Capacitor .047 uF 20%
C449		0160-4791	Capacitor 10pF 5% 100V
C450		0160-5422	Capacitor .047 uF 20%
C451	E4351B	0160-4832	Capacitor.01UF 10%
C452		0160-4355	Capacitor .01uF 10%
C453		0160-4846	Capacitor 1500pF 100V
C454		0160-5422	Capacitor .047 uF 20%
C455		0180-4129	Capacitor 1uF 35V
C456		0160-4805	Capacitor 47pF 5% 100V
C457		0160-4831	Capacitor 4700pF 10%
C458		0160-4787	Capacitor 22pF 5% 100V
C459		0160-4832	Capacitor .01uF 10%
C541	E4350B	0160-4832	Capacitor .01uF 10%
C601	E4350B	0160-6806	Capacitor .1uF 400V
C601	E4351B	0160-4323	Capacitor .047uF 250V
C603		0160-4795	Capacitor 4.7pF
C604		0160-5422	Capacitor .047 uF 20%
C605		0160-5422	Capacitor .047 uF 20%
C606		0160-4800	Capacitor 120pF 5%
C607		0160-5422	Capacitor .047 uF 20%
C608		0160-4801	Capacitor 100pF 5%
C609		0180-0197	Capacitor 2.2uF 20V
C610		0160-4835	Capacitor .1uF 10% 50V
C611		0160-4800	Capacitor 120pF 5%
C700		0160-4281	Capacitor 2200pF 20%
C701		0160-4281	Capacitor 2200pF 20%
C702		0160-7606	Capacitor 1uF 275V
C703		0160-4845	Capacitor 6800pF 20%
C704		0160-4355	Capacitor .01uF 10%
C705		0180-4129	Capacitor 1uF 35V
C706		0180-4129	Capacitor 1uF 35V
C707		0160-4830	Capacitor 2200pF 10%
C709	E4350B	0160-6804	Capacitor .047uF 250V
C709	E4351B	0160-6896	Capacitor0.015uF 400V
C710		0160-6896	Capacitor 0.015uF 400V
C711		0160-4834	Capacitor .047uF 10%
C712		0180-4132	Capacitor 6.8uF 35V
C713		0180-3458	Capacitor 4700uF 50V
C714		0180-3458	Capacitor 4700uF 50V
C715		0180-3458	Capacitor 4700uF 50V
C715	E4351B	0160-5422	Capacitor.047 UF 20%
C716		0160-4904	Capacitor 6800pF 5%
C718		0160-5469	Capacitor 1uF 10% 50V
C719	E4350B	0180-4263	Capacitor 4000uF 125V
C719	E4351B	0180-4311	Capacitor1200UF 250V
C720	E4350B	0180-4263	Capacitor 4000uF 125V
C720	E4351B	0180-4311	Capacitor1200UF 250V
C721	E4350B	0180-3497	Capacitor 6800uF 16V

**Table 5-7. Parts List for Main PC Board Assembly A1(Continued)**

<b>Reference Designator</b>	<b>Model</b>	<b>Part Number</b>	<b>Description</b>
C722	E4351B	0180-4311	Capacitor 1200UF 250V
C722	E4350B	0180-4263	Capacitor 4000uF 125V
C723		0160-0168	Capacitor .1uF 10%
C724		0160-5422	Capacitor .047 uF 20%
C725	E4350B	0160-5422	Capacitor .047 uF 20%
CR700		5060-3376	SCR/Diode Assembly
D401		1901-0033	Diode
D402		1901-0033	Diode
D403		1901-0033	Diode
D404		1901-0033	Diode
D405		1901-0033	Diode
D406		1901-1128	Diode
D407		1901-1128	Diode
D408		1901-0033	Diode
D409		1901-0033	Diode
D410		1901-1098	Diode
D411		1901-1098	Diode
D413		1901-1098	Diode
D415		1901-0518	Diode
D416		1901-0050	Diode
D417		1901-0050	Diode
D418		1901-0033	Diode
D419		1901-1098	Diode
D420		1901-1098	Diode
D421		1901-1098	Diode
D422		1901-0050	Diode
D423		1901-0050	Diode
D424		1901-1098	Diode
D425		1901-1098	Diode
D426		1901-0050	Diode
D427		1901-0050	Diode
D428		1901-0731	Diode
D429		1901-0731	Diode
D430		1901-0050	Diode
D431		1901-0050	Diode
D601		1901-0050	Diode
D602		1901-0050	Diode
D603		1901-0050	Diode
D604		1901-0050	Diode
D605		1901-0050	Diode
D606		1901-0731	Diode
D607		1901-0050	Diode
D608		1901-0050	Diode
D609		1901-1214	Diode
D700		1901-1098	Diode
D701		1901-1098	Diode
D702		1901-0719	Diode
D703		1901-0719	Diode
D704		1901-0719	Diode
D705		1901-0719	Diode

**Table 5-7. Parts List for Main PC Board Assembly A1 (Continued)**

<b>Reference Designator</b>	<b>Model</b>	<b>Part Number</b>	<b>Description</b>
D706		1901-1098	Diode
D707		1901-0992	Diode
D709		1906-0383	Full Wave Rectifier
D710		1901-1087	Diode
D711		1901-1087	Diode
D712		1901-0050	Diode
F700		2110-0685	Fuse, Subminiature, 7A
F701		2110-0685	Fuse, Subminiature, 7A
F703		2110-0688	Fuse, 3A 125V
F704		2110-0697	Fuse, Subminiature, 15A
F705		2110-0697	Fuse, Subminiature, 15A
J405		1251-4781	Connector
J411		1251-4781	Connector
J450		1251-7616	Connector
J451		1252-3771	AC Line Module
J600		1251-4246	Connector, TP
J601		1251-4245	Connector, 2 pin
J640		1252-3693	Connector
J670		1251-8184	Modular Phone Rcpt
J671		1251-8184	Modular Phone Rcpt
J672		1251-8184	Modular Phone Rcpt
J673		1251-8184	Modular Phone Rcpt
J690		06652-00005	Bus Bar
J691		06652-00005	Bus Bar
J900		1251-8601	Connector, TP
L701		5080-2321	Output Choke
Q206		5060-3250	Transistor/Heatsink Assy
Q401		1855-0727	MOSFET
Q402		1853-0281	Transistor
Q403		1854-0872	Transistor
Q600		1853-0336	Transistor
Q601		1853-0336	Transistor
Q602		1853-0336	Transistor
Q603		1853-0336	Transistor
Q604		1854-0575	Transistor
Q605		1855-0727	MOSFET
Q700		5060-3322	Transistor/Heatsink Assy
Q701		1854-0477	Transistor
R401	E4350B	0698-3153	Resistor 3.83K 1%
R401	E4351B	0757-0440	Resistor 7.5K 1%
R402	E4350B	0698-6320	Resistor 5K .1% .125W
R402	E4351B	0698-6360	Resistor 10K .1%
R403	E4350B	0698-6320	Resistor 5K .1% .125W
R403	E4351B	0698-6360	Resistor 10K .1%
R404		0698-5454	Resistor 9K .1% .125W
R405	E4350B	0757-0288	Resistor 9.09K 1%
R406	E4350B	0699-3446	Resistor 125K .05%
R406	E4351B	0699-3104	Resistor 250K .125W
R407		0698-5454	Resistor 9K .1% .125W



**Table 5-7. Parts List for Main PC Board Assembly A1 (Continued)**

<b>Reference Designator</b>	<b>Model</b>	<b>Part Number</b>	<b>Description</b>
R408	E4350B	0699-3446	Resistor 125K .05%
R408	E4351B	0699-3104	Resistor 250K .125W
R409	E4350B	0757-0288	Resistor 9.09K 1%
R410		0698-0082	Resistor 464 1% .125W
R411		0698-3279	Resistor 4.99K 1%
R412		0683-2015	Resistor 200 5% .25W
R413	E4350B	0698-3153	Resistor 3.83K 1%
R413	E4351B	0757-0440	Resistor 7.5K 1%
R414		8159-0005	Resistor-Zero Ohms
R415		0698-6360	Resistor 10K .1%
R416		0698-6360	Resistor 10K .1%
R417		8159-0005	Resistor-Zero Ohms
R418		0698-6630	Resistor 20K .1%
R419		0698-6360	Resistor 10K .1%
R420		0698-6630	Resistor 20K .1%
R421		0698-6630	Resistor 20K .1%
R422		0698-6360	Resistor 10K .1%
R423		0698-6630	Resistor 20K .1%
R424		8159-0005	Resistor-Zero Ohms
R425		0699-0118	Resistor 20K .1% .1W
R426		0698-6362	Resistor 1K .1% .125W
R427		0698-6362	Resistor 1K .1% .125W
R428		0699-0118	Resistor 20K .1% .1W
R429		8159-0005	Resistor-Zero Ohms
R430		8159-0005	Resistor-Zero Ohms
R431		8159-0005	Resistor-Zero Ohms
R432		0699-0118	Resistor 20K .1% .1W
R433		0698-6344	Resistor 900 .1%
R434		0698-6344	Resistor 900 .1%
R435		0699-0118	Resistor 20K .1% .1W
R436		8159-0005	Resistor-Zero Ohms
R437		0699-0533	Resistor 4.64K .1%
R438		0698-3136	Resistor 17.8K 1%
R439		0757-0288	Resistor 9.09K 1%
R440		0699-0533	Resistor 4.64K .1%
R441	E4350B	0699-0088	Resistor 1.2M 1%
R441	E4351B	0698-8826	Resistor 825K 1%
R442		0698-3155	Resistor 4.64K 1%
R443		0757-0446	Resistor 15K 1% .125W
R444		0757-0439	Resistor 6.81K 1%
R445	E4350B	0698-8827	Resistor 1M 1% .125W
R445	E4351B	0699-0070	Resistor 3.16M 1%
R446		0698-3260	Resistor 464K 1%
R447	E4350B	0757-0465	Resistor 100K 1%
R447	E4351B	0757-0471	Resistor 182K 1%
R448		0698-0084	Resistor 2.15K 1%
R449		0698-3155	Resistor 4.64K 1%
R450		0757-0446	Resistor 15K 1% .125W
R451		0698-3260	Resistor 464K 1%
R452		0698-6320	Resistor 5K .1% .125W

**Table 5-7. Parts List for Main PC Board Assembly A1 (Continued)**

<b>Reference Designator</b>	<b>Model</b>	<b>Part Number</b>	<b>Description</b>
R453		0699-0533	Resistor 4.64K .1%
R455		0698-0084	Resistor 2.15K 1%
R456		0757-0401	Resistor 100 1% .125W
R458		0698-3428	Resistor 14.7 1%
R460		0757-0459	Resistor 56.2K 1%
R461		0698-3162	Resistor 46.4K 1%
R462		0698-3162	Resistor 46.4K 1%
R463		0757-0283	Resistor 2K 1% .125W
R464		0698-4435	Resistor 2.49K 1%
R465		0698-6360	Resistor 10K .1%
R466		0757-0430	Resistor 2.21K 1%
R467	E4350B	0757-0270	Resistor 249K 1%
R467	E4351B	0757-0468	Resistor 130K 1%
R468		0698-5454	Resistor 9K .1% .125W
R469		0698-3700	Resistor 715 1% .125W
R471		0757-0401	Resistor 100 1% .125W
R473		0757-0427	Resistor 1.5K 1%
R474		0698-3156	Resistor 14.7K 1%
R475	E4350B	0757-0418	Resistor 619 1% .125W
R475	E4351B	0757-0283	Resistor 221
R476		0698-3156	Resistor 14.7K 1%
R477		8159-0005	Resistor-Zero Ohms
R478		0698-3279	Resistor 4.99K 1%
R479		0698-4435	Resistor 2.49K 1%
R480	E4350B	0757-0418	Resistor 619 1% .125W
R480	E4351B	0757-0282	Resistor 221 1% .125W
R481		0698-3156	Resistor 14.7K 1%
R482		0698-3557	Resistor 806 1% .125W
R483		0757-0279	Resistor 3.16K 1%
R484		0757-0199	Resistor 21.5K 1%
R485		0757-0199	Resistor 21.5K 1%
R488		0698-3279	Resistor 4.99K 1%
R489	E4350B	0757-0451	Resistor 24.3K 1%
R489	E4351B	0757-0457	Resistor 47.5K 1%
R490		0698-6360	Resistor 10K .1%
R491		0698-6360	Resistor 10K .1%
R492		0757-0433	Resistor 3.32K 1%
R493	E4350B	0699-1254	Resistor 536K 1%
R493	E4351B	0698-8827	Resistor 221K 1%
R494	E4350B	0757-0412	Resistor 365 1% .125W
R494	E4351B	0757-0421	Resistor 1M 1% .125W
R495		0757-0434	Resistor 3.65K 1%
R496		0757-0469	Resistor 150K 1%
R497		0698-3160	Resistor 31.6K 1%
R498		0698-3162	Resistor 46.4K 1%
R499		0757-0463	Resistor 82.5K 1%
R500		0757-0407	Resistor 200 1% .125W
R501		0757-1093	Resistor 3K 1% .125W
R502	E4350B	0698-3493	Resistor 4.12K 1%
R502	E4351B	0757-0427	Resistor 1.5K 1%
R503	E4350B	0698-3156	Resistor 14.7K 1%
R503	E4351B	0698-4121	Resistor 11.3K 1%

**Table 5-7. Parts List for Main PC Board Assembly A1 (Continued)**

<b>Reference Designator</b>	<b>Model</b>	<b>Part Number</b>	<b>Description</b>
R504		0757-0442	Resistor 10K 1% .125W
R505		0757-0429	Resistor 1.82K 1%
R506		0698-3160	Resistor 31.6K 1%
R507		0757-0442	Resistor 10K 1% .125W
R508		0757-0444	Resistor 12.1K 1%
R509		0757-0280	Resistor 1K 1% .125W
R510		0698-3279	Resistor 4.99K 1%
R511		0757-0430	Resistor 2.21K 1%
R512		0757-0401	Resistor 100 1% .125W
R513		0757-0401	Resistor 100 1% .125W
R514		0757-0284	Resistor 150 1% .125W
R515		0757-0284	Resistor 150 1% .125W
R516		0698-0084	Resistor 2.15K 1%
R517		0699-1797	Resistor 10M 5% .25W
R520		0757-0419	Resistor 681 1% .125W
R521		0757-0470	Resistor 162K 1%
R522		0757-0442	Resistor 10K 1% .125W
R523		0757-0472	Resistor 200K 1%
R524		0698-8826	Resistor 825K 1%
R525		0698-3156	Resistor 14.7K 1%
R526		0757-0427	Resistor 1.5K 1%
R601		0757-0465	Resistor 100K 1%
R602		0698-4037	Resistor 46.4 1%
R603		0757-0407	Resistor 200 1% .125W
R604		0698-4037	Resistor 46.4 1%
R605		0757-0407	Resistor 200 1% .125W
R606		0698-4037	Resistor 46.4 1%
R607		0757-0407	Resistor 200 1% .125W
R608	E4350B	8159-0005	Resistor-Zero Ohms
R608	E4351B	0757-0463	Resistor 82.5K 1%
R609		0757-0463	Resistor 82.5K 1%
R610	E4350B	0698-0082	Resistor 464 1% .125W
R610	E4351B	0757-0280	Resistor 1K 1% .125W
R611		0698-6358	Resistor 100K .1%
R612		0757-0463	Resistor 82.5K 1%
R613	E4350B	8159-0005	Resistor-Zero Ohms
R613	E4351B	0757-0463	Resistor 82.5K 1%
R614		0698-6358	Resistor 100K .1%
R615	E4350B	8159-0005	Resistor-Zero Ohms
R615	E4351B	0698-6629	Resistor 60K .1%
R616	E4350B	0698-6977	Resistor 30K .1% .125
R616	E4351B	0698-6358	Resistor 100K .1%
R617		0698-5454	Resistor 9K .1% .125W
R618	E4350B	0698-8826	Resistor 825K 1%
R618	E4351B	0699-1972	Resistor 1.74M 1%
R619	E4350B	0698-6977	Resistor 30K .1% .125
R619	E4351B	0698-6358	Resistor 100K .1%
R620		0757-0442	Resistor 10K 1% .125W
R621		0757-0415	Resistor 475 1% .125W
R622		0757-0281	Resistor 2.74K 1%
R623		0698-5454	Resistor 9K .1% .125W

**Table 5-7. Parts List for Main PC Board Assembly A1 (Continued)**

<b>Reference Designator</b>	<b>Model</b>	<b>Part Number</b>	<b>Description</b>
R624		8159-0005	Resistor-Zero Ohms
R625	E4350B	0698-8826	Resistor 825K 1%
R625	E4351B	0699-1972	Resistor 1.74M 1%
R626		8159-0005	Resistor-Zero Ohms
R627		8159-0005	Resistor-Zero Ohms
R628	E4350B	8159-0005	Resistor-Zero Ohms
R628	E4351B	0698-6629	Resistor 60K .1%
R630		0757-0395	Resistor 56.2 1%
R631		0757-0199	Resistor 21.5K 1%
R632		0757-0401	Resistor 100 1% .125W
R633		0757-0469	Resistor 150K 1%
R634		0757-0446	Resistor 15K 1% .125W
R635		0757-0430	Resistor 2.21K 1%
R636		0757-0415	Resistor 475 1% .125W
R637		0757-0415	Resistor 475 1% .125W
R638		0757-0407	Resistor 200 1% .125W
R639		0698-3155	Resistor 4.64K 1%
R640		0698-3155	Resistor 4.64K 1%
R641		0698-3153	Resistor 3.83K 1%
R642		0698-3155	Resistor 4.64K 1%
R643		0698-8695	Resistor 36K .1%
R644		0698-0084	Resistor 2.15K 1%
R645		0757-0442	Resistor 10K 1% .125W
R646		0757-0280	Resistor 1K 1% .125W
R647		0683-0475	Resistor 4.7 5% .25W
R648		0683-0475	Resistor 4.7 5% .25W
R649		0757-0280	Resistor 1K 1% .125W
R650		0757-0441	Resistor 8.25K 1%
R651		0757-0465	Resistor 100K 1%
R652		0698-3160	Resistor 31.6K 1%
R653		0757-0199	Resistor 21.5K 1%
R654		0698-8816	Resistor 2.15 1%
R655		0757-0199	Resistor 21.5K 1%
R656		0757-0199	Resistor 21.5K 1%
R657		0698-3162	Resistor 46.4K 1%
R658		0757-0199	Resistor 21.5K 1%
R659		8159-0005	Resistor-Zero Ohms
R661		0757-0401	Resistor 100 1% .125W
R662		0757-0280	Resistor 1K 1% .125W
R700		0683-1055	Resistor 1M 5% .25W
R701		0699-1797	Resistor 10M 5% .25W
R702		0683-0335	Resistor 3.3 5% .25W
R703	E4350B	0811-3764	Resistor .025 7W 2%
R703	E4351B	0811-3770	Resistor .05 OHM 1%
R704		8159-0005	Resistor-Zero Ohms
R705		0698-6359	Resistor 80K 0.1%
R706		0698-6979	Resistor 111.1K .1%
R707		0699-1212	Resistor 19K .1%
R708		8159-0005	Resistor-Zero Ohms
R709		0699-4707	Resistor .25 Ohm
R710		0811-2201	Resistor 270 5% 2W PW
R711		0811-2201	Resistor 270 5% 2W PW

**Table 5-7. Parts List for Main PC Board Assembly A1 (Continued)**

<b>Reference Designator</b>	<b>Model</b>	<b>Part Number</b>	<b>Description</b>
R712		0686-2225	Resistor 2.2K 5% .5W
R713	E4350B	0811-3932	Resistor 13 10W
R714	E4351B	0811-3932	Resistor-13 10W
R716	E4351B	0811-3932	Resistor-13 10W
R717		8159-0005	Resistor-Zero Ohms
R718		0811-2568	Resistor 1 1% 3W PWI
R719		0757-0280	Resistor 1K 1% .125W
R720		0757-0279	Resistor 3.16K 1%
R721	E4350B	0811-1873	Resistor 3K 5% 10W PW
R721	E4351B	0811-1914	Resistor 5K 5% 10W PW
R722	E4350B	0811-1873	Resistor 3K 5% 10W PW
R722	E4351B	0811-1914	Resistor 5K 5% 10W PW
R723	E4350B	0698-3628	Resistor 220 5% 2W MO
R723	E4351B	0698-3627	Resistor 200 5% 2W MO
R724		0698-0082	Resistor 464 1% .125W
R725	E4350B	0811-1586	Resistor 1K 5% 10W PW
R725	E4351B	0811-1873	Resistor 3K 5% 10W PW
R726		8159-0005	Resistor-Zero Ohms
R727		0757-0280	Resistor 1K 1% .125W
R728		0699-4707	Resistor .25 Ohm
R729		0757-0419	Resistor 681 1% .125W
REF D709	E4350B	0515-0383	Machine Screw
REF D709	E4350B	1205-0862	Heat Sink
REF D7092	E4351B	0515-0383	Machine Screw
REF D7094	E4351B	1205-0862	Heat Sink
REF J451	E4350B	3050-0891	Flat Washer
REF J451	E4350B	0535-0031	Hex Nut w/Lock Washer
REF J690, J691	E4350B	2190-0586	Helical Lock Washer
REF J690, J691	E4350B	0515-0909	Machine Screw
REF J451	E4351B	570-0647	STUD-STD-PRS-IN
REF J4512	E4351B	0535-0031	NUT-HEX W/LKWR
REF J4513	E4351B	3050-0891	WSHR-FL MTLC
REF J6902,6912	E4351B	2190-0586	WSHR-LK HLCL
REF J690,J691	E4351B	0515-0909	SCR-MACH MAX .07
S610		3101-2894	Push Button Switch, DPDT
U401		1826-1533	Integrated Circuit
U402		1826-1533	Integrated Circuit
U403		1826-2252	Integrated Circuit
U404		1826-1533	Integrated Circuit
U405		1826-0412	Integrated Circuit
U406		1858-0077	Transistor Array
U407		1826-0175	Integrated Circuit
U408		1826-1533	Integrated Circuit
U409		1826-1533	Integrated Circuit
U410		1990-1502	Opto Isolator
U411		1820-3081	Integrated Circuit
U600		1826-1895	Integrated Circuit
U601		1858-0077	Transistor Array
U602		1858-0047	Transistor Array
U603		1826-0412	Integrated Circuit

**Table 5-7. Parts List for Main PC Board Assembly A1 (Continued)**

<b>Reference Designator</b>	<b>Model</b>	<b>Part Number</b>	<b>Description</b>
U604		1858-0077	Transistor Array
U605		1858-0076	Transistor Array
U700		5060-3321	IC/Heat Sink Assy
U701		5063-2351	IC/Heat Sink Assy
U702		1826-1533	Integrated Circuit
U703		5063-2328	IC/Heat Sink Assy
VR400		1902-0556	Zener Diode 20V 5%
VR600		1902-0947	Zener Diode 3.6V 5%
VR601		1902-0947	Zener Diode 3.6V 5%
VR602		1902-3104	Zener Diode 5.62V 5%
VR603		1902-0958	Zener Diode 10V 5%
VR700		1902-0957	Zener Diode 9.1 V 5%
VR701		1902-0955	Zener Diode 7.5V 5%
XF450		2110-0927	Fuseholder w/Cap

**Table 5-9. Parts List for GPIB PC Assembly (A2)**

<b>Reference Designator</b>	<b>Part Number</b>	<b>Description</b>
A2	5063-2356	GPIB Board (unchanged)

**Table 5-10. Parts List for Front Panel PC Assembly (A3)**

<b>Reference Designator</b>	<b>Part Number</b>	<b>Description</b>
A3	5063-2360	Front Panel Board (unchanged)

**Table 5-11. Parts List for Top Left Tunnel Board (A4A1)**

<b>Reference Designator</b>	<b>Part-Number</b>	<b>Description</b>
A4A1	5063-4818	Top Left Tunnel Board
C201	0160-4801	Capacitor 100PF 5%
C202	0160-4801	Capacitor 100PF 5%
C203	0160-4801	Capacitor 100PF 5%
C204	0160-4801	Capacitor 100PF 5%
C205	0160-4835	Capacitor .1UF 10% 50V
C206	0160-4835	Capacitor .1UF 10% 50V
C208	0160-6838	Capacitor 2200pf 1KV
C211	0160-4812	Capacitor 220PF 5%
D201	1901-1098	Diode
D203	1901-0050	Diode
D204	1901-0050	Diode
D205	1901-0050	Diode
F201	2110-0297	Fuse, 0.5A, 125V
F202	2110-0297	Fuse, 0.5A, 125V
F203	2110-0297	Fuse, 0.5A, 125V
F204	2110-0297	Fuse, 0.5A, 125V
F205	8159-0005	Resistor, Zero Ohms
F206	8159-0005	Resistor, Zero Ohms
F207	8159-0005	Resistor, Zero Ohms
F208	8159-0005	Resistor, Zero Ohms
J201	1251-8184	Modular Phone Rcpt
J202	1251-4781	Connector
Q201	1855-0849	FET
Q203	1855-0849	FET
Q205	1854-0989	Transistor
Q207	1855-0849	FET
Q206	5060-3250	Transistor/Heat Sink Assy
R201	0811-3989	Resistor 1.5 1% 3W
R202	0698-3430	Resistor 21.5 1%
R203	0698-3156	Resistor 14.7K 1%
R204	0757-0280	Resistor 1K 1% .125W
R206	0811-3989	Resistor 1.5 1% 3W
R207	0698-3430	Resistor 21.5 1%
R208	0698-3156	Resistor 14.7K 1%
R209	0757-0280	Resistor 1K 1% .125W
R210	0698-3456	Resistor 287K 1%
R212	0757-0316	Resistor 42.2 1%
R213	0698-3441	Resistor 215 1% .125W
R214	0698-0085	Resistor 2.61K 1%
R215	0698-4503	Resistor 66.5K 1%
R216	0811-3989	Resistor 1.5 1% 3W
R217	0698-3430	Resistor 21.5 1%
R218	0698-3156	Resistor 14.7K 1%
R219	0757-0280	Resistor 1K 1% .125W
R220	0757-0468	Resistor 130K 1%
R221	0757-0280	Resistor 1K 1% .125W
R224	0698-3628	Resistor 220 5% 2W MO
R229	8159-0005	Resistor, Zero Ohms
R230	8159-0005	Resistor, Zero Ohms
R232	8159-0005	Resistor, Zero Ohms
R233	8159-0005	Resistor, Zero Ohms
	0340-0458	Insulator (Ref Q205)
	0515-0064	Screw, Mach M3x0.5x16mm pan head (Ref Q201,Q203,Q205,Q207)
	1200-1158	Transistor Socket (Ref Q201,Q203,Q205,Q207)
	2190-0584	Washer, helical lock (Ref Q201,Q203,Q205,Q207)

**Table 5-12. Parts List for Right Tunnel Boards (A4A2 & A4A4)**

<b>Reference Designator</b>	<b>Part-Number</b>	<b>Description</b>
A4A2/A4	5063-4816	Right Tunnel Board
C301	0160-4801	Capacitor 100PF 5%
C302	0160-4801	Capacitor 100PF 5%
C303	0160-4801	Capacitor 100PF 5%
C304	0160-4801	Capacitor 100PF 5%
C305	0160-4835	Capacitor .1UF 10% 50V
C306	0160-4835	Capacitor .1UF 10% 50V
C309	0160-6838	Capacitor 2200pf 1KV
D302	1901-0050	Diode
D303	1901-0050	Diode
D305	1901-0050	Diode
F301	2110-0297	Fuse .5A 125V
F302	2110-0297	Fuse .5A 125V
F303	2110-0297	Fuse .5A 125V
F304	8159-0005	Resistor-Zero Ohms
F305	8159-0005	Resistor-Zero Ohms
F306	8159-0005	Resistor-Zero Ohms
F307	8159-0005	Resistor-Zero Ohms
J300	1251-4245	Connector, 2 pin
J301	1251-8184	Mod Phone Receptacle
J302	1251-4781	Connector
Q301	1855-0849	FET
Q303	1855-0849	FET
Q305	1855-0849	FET
Q307	1855-0849	FET
R301	0811-3989	Resistor 1.5 1% 3W
R302	0698-3430	Resistor 21.5 1%
R303	0698-3156	Resistor 14.7K 1%
R304	0757-0280	Resistor 1K 1% .125W
R305	0757-0473	Resistor 221K 1%
R306	0811-3989	Resistor 1.5 1% 3W
R307	0698-3430	Resistor 21.5 1%
R308	0698-3156	Resistor 14.7K 1%
R309	0757-0280	Resistor 1K 1% .125W
R310	0757-0465	Resistor 100K 1%
R311	0811-3989	Resistor 1.5 1% 3W
R312	0698-3430	Resistor 21.5 1%
R313	0698-3156	Resistor 14.7K 1%
R314	0757-0280	Resistor 1K 1% .125W
R315	0757-0460	Resistor 61.9K 1%
R316	0811-3989	Resistor 1.5 1% 3W
R317	0698-3430	Resistor 21.5 1%
R318	0698-3156	Resistor 14.7K 1%
R319	0757-0280	Resistor 1K 1% .125W
R320	0757-0458	Resistor 51.1K 1%
R323	0698-3628	Resistor 220 5% 2W MO
R329	8159-0005	Resistor-Zero Ohms
R330	8159-0005	Resistor-Zero Ohms
R331	8159-0005	Resistor-Zero Ohms
R332	8159-0005	Resistor-Zero Ohms
RT301	06652-60006	Thermistor, Assembly
	0515-0064	Screw, Mach M3x0.5x16mm pan head (Ref Q301,Q303,Q305,Q307)
	1200-1158	Transistor Socket (Ref Q301,Q303,Q305,Q307)
	2190-0584	Washer, helical lock (Ref Q301,Q303,Q305,Q307)



**Table 5-11. Parts List for Bottom Left Tunnel Board (A4A3)**

<b>Reference Designator</b>	<b>Part-Number</b>	<b>Description</b>
A4A3	5063-4820	Bottom Left Tunnel Board
C201	0160-4801	Capacitor 100PF 5%
C202	0160-4801	Capacitor 100PF 5%
C204	0160-4801	Capacitor 100PF 5%
C205	0160-4835	Capacitor .1UF 10% 50V
C206	0160-4835	Capacitor .1UF 10% 50V
C209	0160-6806	Capacitor .1UF 400V
C208	0160-6838	Capacitor 2200pf 1KV
Q201	1855-0849	FET
Q203	1855-0849	FET
Q205	1854-0989	Transistor
Q207	1855-0849	FET
R203	0698-3156	Resistor 14.7K 1%
R208	0698-3156	Resistor 14.7K 1%
R218	0698-3156	Resistor 14.7K 1%
R202	0698-3430	Resistor 21.5 1%
R207	0698-3430	Resistor 21.5 1%
R217	0698-3430	Resistor 21.5 1%
R210	0698-3456	Resistor 287K 1%
R224	0698-3628	Resistor 220 5% 2W MO
R204	0757-0280	Resistor 1K 1% .125W
R209	0757-0280	Resistor 1K 1% .125W
R219	0757-0280	Resistor 1K 1% .125W
R220	0757-0468	Resistor 130K 1%
R201	0811-3989	Resistor 1.5 1% 3W
R206	0811-3989	Resistor 1.5 1% 3W
R216	0811-3989	Resistor 1.5 1% 3W
J202	1251-4781	Connector
J201	1251-8184	Modular Phone Rcpt
D203	1901-0050	Diode
D204	1901-0050	Diode
D205	1901-0050	Diode
F201	2110-0297	Fuse .5A 125V
F202	2110-0297	Fuse .5A 125V
F203	2110-0297	Fuse .5A 125V
F205	8159-0005	Resistor, Zero Ohms
F206	8159-0005	Resistor, Zero Ohms
F207	8159-0005	Resistor, Zero Ohms
R229	8159-0005	Resistor, Zero Ohms
R230	8159-0005	Resistor, Zero Ohms
R231	8159-0005	Resistor, Zero Ohms
R232	8159-0005	Resistor, Zero Ohms
R233	8159-0005	Resistor, Zero Ohms
R234	8159-0005	Resistor, Zero Ohms
R235	8159-0005	Resistor, Zero Ohms
	0340-0458	Insulator (Ref Q205)
	0515-0064	Screw, Mach M3x0.5x16mm pan head (Ref Q201,Q203,Q205,Q207)
	1200-1158	Transistor Socket (Ref Q201,Q203,Q205,Q207)
	2190-0584	Washer, helical lock (Ref Q201,Q203,Q205,Q207)

**Table 5-13. Parts List for DSP Board (A5)**

Reference Designator	Part Number	Description
A5	5063-4811	DSP Board
	5080-2559	ROM High
	5080-2560	ROM Low

**Table 5-14. Parts List for Adapter PC Assembly (A6)**

Reference Designator	Part Number	Description
A6	5063-4852	Access Panel PCA
C8	0160-4833	Capacitor, 0.022uF
C1	0160-5422	Capacitor 0.047uF
C2	0160-5422	Capacitor 0.047uF
C4	0160-5422	Capacitor 0.047uF
C5	0160-5422	Capacitor 0.047uF
C6	0180-0393	Capacitor 39uF, 10V
C7	0180-0393	Capacitor 39uF, 10V
J501	1251-7330	Modular Phone Rcpt
J900	1252-0242	Connector Post
P715	1252-2634	Connector Post
P721	1252-6419	Connector Post
P722	1252-6419	Connector Post
Q501	1855-0727	MOSFET
Q502	1855-0727	MOSFET
R1	0699-0642	Resistor 10K, 0.1%, 0.1W
R2	0699-0642	Resistor 10K, 0.1%, 0.1W
R3	0698-3700	Resistor 715 Ohm, 1%, 0.125W
R4	0699-0642	Resistor 10K, 0.1%, 0.1W
R5	0699-0642	Resistor 10K, 0.1%, 0.1W
R6	0699-0642	Resistor 10K, 0.1%, 0.1W
R7	0699-0642	Resistor 10K, 0.1%, 0.1W
R8	0757-0413	Resistor 392 Ohm, 1%, 0.125W
R9	0698-3279	Resistor 4.99K, 1%
R501	0757-0442	Resistor 10K, 1%, 0.125W
R502	0757-0442	Resistor 10K, 1%, 0.125W
U1	1826-1533	IC
	<b>Mechanical</b>	
	0380-1262	Standoff, Hex, 12mm
	0515-0430	Machine Screw (qty 2)

**Table 5-15. Parts List for Phone Adapter PC Assembly (A7)**

Reference Designator	Part Number	Description
A7	5063-4813	Phone PCA
	0757-0442	Resistor, 10K, 1%, 0.125W
	1251-7330	Modular Phone Rcpt
	1252-2634	Connector, Post
	1855-0727	MOSFET

## Chapter 6 Differences

### Test Points

Table 6-3. Test Points

Test Point	Signal	Measurement and Conditions
<b>A1 Main Board (Sheets 1-4); A5 DSP Board</b>		
Connect meter or scope common to Test Point (TP) 9 when taking measurements at Test Points 10 through 46		
TP9 R703-3	Secondary common (sheet 1)	R703-3 (RmINB)
TP10 F703	+5V Sec Bias (sheet 1)	+5V +/- 0.2V
TP11 R704	+15 Sec Bias (sheet 1)	+15 +/- 0.6V
TP12 Q700 (heat sink)	+24V (sheet 1)	+21V to +27V (1V p-p ripple)
TP13 R708	-15V Sec Bias (sheet 1)	-15V +/- 1V
TP14 U701-2	-25V (sheet 1)	-22V to -28V (300mV p-p ripple)
TP15 U702-3	Fan speed control (sheet 1)	+3V with no load connected and ambient temperature 25C.
TP16 D701 anode	Fan speed control (sheet 1)	+2.95V with no load connected and ambient temperature 25C.
TP17 U603-5	PCLR* (DSP Board) (sheet 3)	Goes low for approximately 40mS at power on, then goes high (5V).
TP18 U603-7	Shutdown circuit (sheet 3)	+8.69V with output on
TP19 U602-16	Shutdown circuit (sheet 3)	+0.7V with output off, +15.2V with output on.
TP20 VR602 anode	+9V Gated (sheet 3)	+9V
TP21 D606 anode	-15V Gated(sheet 3)	-14.2V
TP24 R421	CC_Prog (sheet 2)	-4.2V (approximate) with full-scale current programmed.
TP25 R623	CV_Prog (sheet 2)	-4.3V (approximate) with full-scale voltage programmed.

**Table 6-3. Test Points (continued)**

<b>Test Point</b>	<b>Signal</b>	<b>Measurement and Conditions</b>
The measurements at test points 26 through 39 were taken with full scale voltage and full scale current programmed. The measurements were made first in the CV mode with no load and then in the CC mode with the load set for full-scale output voltage and current. If the CC annunciator is not on, set the current to a slightly lower value until it comes on.		
TP26 D413 cathode	CC control (sheet 2)	1.57V in CV mode 0.15V in CC mode
TP27 R703	RmOUTB (sheet 2)	3.3mV in CV mode with no load 0.19V in CC mode with 8A load
TP28 U403-7	I <sub>mon</sub> (sheet 2)	0.9mV in CV mode with no load 4.39V in CC mode with 8A load
TP29 R430	Neg I <sub>mon</sub> (sheet 2)	13.9mV in CV mode -3.9V in CC mode with 8A load
TP31 U407-7	CC* (sheet 2)	5V in CV mode 0V on CC mode
TP32 U408-7	CV control (sheet 2)	-0.8V in CV mode 1.55V in CC mode
TP33 U401-7	V <sub>mon</sub> (sheet 2)	4.1V in CV or CC mode (@ full scale voltage output)
TP34 U407-12	CV*(sheet 2)	0V in CV mode 5V in CC mode
TP35 U408-3	CV or CC control (sheet 2)	0.5V in CV mode 0.98V in CC mode
TP36 D429 anode	FET control (sheet 2)	0.05V in CV mode 0.98V in CC mode
TP37 D419 cathode	Gross current limit circuit (sheet 2)	14.5V in CV or CC mode
TP38 D425 cathode	DP Control (sheet 2)	0.22V in CV mode 1.9V in CC mode
TP39 R444	OV_Prog (sheet 2)	5.17V @ full scale OV programmed
TP40 R706	Fan_Prog (sheet 1)	0.5V approximate @ low speed 3.2V approximate @ medium speed (4A output) 5V approximate @ high speed (8A output)
TP41 R453	OC_Prog (sheet 2)	4.6V (turn-on default)
TP42 U405-5	OV circuit (sheet 2)	4.5V with full scale voltage programmed 0V with zero volts programmed
TP43 U405-7	OV circuit (sheet 2)	5V (no OV condition)
TP44 R510	Therm HS(sheet 2)	3.2V with heatsink @23C (voltage decreases as temperature increases)
TP45 D430 anode	OC circuit (sheet 2)	5V with no overcurrent condition
TP46 D407 cathode	OC circuit (sheet 2)	0.45V with no overcurrent condition 2.3V in OC Protect

**Table 6-3. Test Points (continued)**

<b>Test Point</b>	<b>Signal</b>	<b>Measurement and Conditions</b>
<b>A4A1/A4A3 LEFT TUNNEL BOARDS (FIGURE 6-6)</b>		
<p>Leave meter or scope common connected to test point ((9)) when taking measurements at test points 47 through 64. The measurements were taken with full-scale voltage and current programmed. The measurements were made first in the CV mode with no load, and then in the CC mode with the load set for full-scale voltage and current. Test points are listed for the first regulator (closest to fan) and the last regulator stages only. The number of regulator stages that will be on (conducting) depends upon the output current. In the CV mode with no load connected (no output current), only one or two stages will be on conducting current through the down programmer stages. The remaining regulator stages will be off (not conducting). In the CC mode with the load set for full-scale output voltage and current, all regulator stages will be on.</p>		
TP47 U201-3	OUTPUT CONTROL (comparator + input to all stages)	0.05V in CV mode 0.98V in CC mode
TP48 U201-2	Stage 1 comparator -input	0.05V in CV mode 0.98V in CC mode
TP49 U201-1	Stage 1 FET driver input	3.75V in CV mode 4.78V in CC mode
TP51 U202-2	Stage 3 comparator -input	0.05V in CV mode 0.98V in CC mode
TP52 U202-1	Stage 3 FET driver control	-0.36V in CV mode 4.65V in CC mode
TP54 U202-5	DP CONTROL	0.22V in CV mode 1.9V in CC mode
TP55 U202-6	DP stage comparator -input	0.22V in CV mode 1.9V in CC mode
TP56 U202-7	DP stage comparator output	-0.66V in CV mode 2.47V in CC mode
<b>A4A2/A4A4 RIGHT TUNNEL BOARDS (FIGURE 6-7)</b>		
The same measurement conditions apply as described for the A4A1/A4A3 Left Tunnel Boards.		
TP58 U301-3	OUTPUT CONTROL	47mV in CV mode 0.99V in CC mode
TP59 U301-2	Stage 1 comparator -input	47mV in CV mode 0.98V in CC mode
TP60 U301-1	Stage 1 FET driver control	3.3V in CV mode 4.75V in CC mode
TP62 U302-2	Stage 4 comparator -input	45mV in CV mode 0.98V in CC mode
TP63 U302-1	Stage 4 FET driver control	-0.45V in CV mode 4.5V in CC mode

**A1 Main Board Schematics (Figure 6-5)**

The four schematic sheets for the A1 board included in this addendum replace figures 6-2 and 6-5 in the standard Service Manual for the Agilent Series 665xA DC Power Supplies.

The assembly drawing for the A1 main board included in this addendum replaces Figure 6-5 in the standard Service Manual.

**Left Tunnel Circuits (Figure 6-6)**

The component locations and schematic drawings for the A4 left tunnel circuits included in this addendum replace figure 6-6 in the standard Service Manual.

**Right Tunnel Circuits (Figure 6-7)**

The component locations and schematic drawings for the A4 right tunnel circuits included in this addendum replace figure 6-7 in the standard Service Manual.

**DSP Board (Figure 6-10)**

The simplified component locations diagram for the A5 DSP board shows the location of the troubleshooting test points on the J721 and J722 connectors as well as the location of the two replaceable ROM chips, U734 and U735.

Because troubleshooting for the A5 DSP Board is to the assembly level only, no schematics or parts lists are included for this board.

**Adapter Board and Phone Adapter Board (Figures 6-11, 6-12)**

The A6 Adapter board connects the A5 DSP board to the A1 main board.  
The A7 Phone Adapter board connects the A5 DSP board to the A2 GPIB board.